

**Air Conditioning Control System  
Centralized Controller  
AE-200A/AE-50A/EW-50A  
AE-200E/AE-50E/EW-50E**

**Instruction Book  
–BACnet® Setting Tool–**

**Contents**

Safety precautions.....	2
1. Introduction .....	4
1-1. Screen images used in this manual.....	4
1-2. BACnet® Setting Tool version.....	4
1-3. PC requirements .....	4
1-4. Connection method.....	5
2. Setting the Operating Environment.....	6
2-1. Setting the IP address of the PC.....	6
2-2. Disabling a proxy server .....	9
2-3. Installing .NET Framework.....	10
3. Installation and uninstallation of BACnet® Setting Tool.....	11
3-1. Installation.....	11
3-2. Uninstallation .....	14
4. Connecting and starting up the BACnet® Setting Tool .....	15
4-1. Connecting the BACnet® Setting Tool .....	15
4-2. Starting up the BACnet® Setting Tool.....	16
4-3. Exiting the BACnet® Setting Tool .....	17
5. BACnet® Setting Tool screens and setting items .....	18
5-1. Screen configuration.....	18
5-2. Menu bar configuration .....	19
5-3. Setting tab configuration .....	20
5-4. Initial setting procedure.....	21
6. Saving settings data .....	24
6-1. Settings data flow .....	24
6-2. Backing up settings data.....	24
7. Menu bar.....	25
7-1. File .....	25
7-2. AE-200/AE-50/EW-50 .....	26
7-3. Help .....	29
8. Setting screens .....	30
8-1. Explanation of Screen Buttons .....	30
8-2. System Settings.....	32
8-3. Group Settings.....	35
8-4. BACnet® Settings.....	36
Attachment 1 BACnet® network configuration and settings examples .....	58
Appendix: Added functions.....	66

Before using the controller,  
please read this Instruction  
Book carefully to ensure proper  
operation.  
Retain this manual for future  
reference.

# Safety precautions

- ▶ Observe these precautions carefully to ensure safety.
- ▶ After reading this manual, pass the manual on to the end user to retain for future reference.
- ▶ The user should keep this manual for future reference and refer to it as necessary. This manual should be made available to those who repair or relocate the units. Make sure that the manual is passed on to any future air conditioning system user.

<b>! WARNING</b>	: indicates a hazardous situation which, if not avoided, could result in death or serious injury.
<b>! CAUTION</b>	: indicates a hazardous situation which, if not avoided, could result in minor or moderate injury.
<b>CAUTION</b>	: addresses practices not related to personal injury, such as product and/or property damage.

## General precautions

### **! WARNING**

Do not install the controller in areas where large amounts of oil, steam, organic solvents, or corrosive gases (such as ammonia, sulfuric compounds, or acids), or areas where acidic/alkaline solutions or special chemical sprays are used frequently. These substances may significantly reduce the performance and corrode the internal parts, resulting in electric shock, malfunction, smoke, or fire.

To reduce the risk of short circuits, current leakage, electric shock, malfunction, smoke, or fire, do not wash the controller with water or any other liquid.

To reduce the risk of electric shock, malfunction, smoke, or fire, do not touch the electrical parts, USB memory, or touch panel with wet fingers.

To reduce the risk of injury or electric shock, before spraying a chemical around the controller, stop the operation and cover the controller.

To reduce the risk of injury, keep children away while installing, inspecting, or repairing the controller.

If you notice any abnormality (e.g., burning smell), stop the operation, turn off the controller, and consult your dealer. Continuing the operation may result in electric shock, malfunction, or fire.

Properly install all required covers to keep moisture and dust out of the controller. Dust accumulation and the presence of water may result in electric shock, smoke, or fire.

### **! CAUTION**

To reduce the risk of fire or explosion, do not place flammable materials or use flammable sprays around the controller.

To reduce the risk of electric shock or malfunction, do not touch the touch panel, switches, or buttons with a sharp object.

To avoid injury from broken glass, do not apply excessive force to the glass parts.

To reduce the risk of injury, electric shock, or malfunction, avoid contact with the sharp edges of certain parts.

---

Consult your dealer for the proper disposal of the controller. Improper disposal will pose a risk of environmental pollution.

## Precautions for relocating or repairing the unit

### **WARNING**

The controller must be repaired or moved only by qualified personnel. Do not disassemble or modify the controller. Improper installation or repair may result in injury, electric shock, or fire.

## Additional precautions

### **CAUTION**

To avoid discoloration, do not use benzene, thinner, or chemical rag to clean the controller. When the controller is heavily soiled, wipe the controller with a well-wrung cloth that has been soaked in water with mild detergent, and then wipe off with a dry cloth.

This appliance is not intended for use by persons (including children) with reduced physical, sensory or mental capabilities, or lack of experience and knowledge, unless they have been given supervision or instruction concerning use of the appliance by a person responsible for their safety. Children should be supervised to ensure that they do not play with the appliance.

# 1. Introduction

This manual is the Instruction Book for AE-200/AE-50/EW-50 (hereinafter referred to as “AE-200”) BACnet® Setting Tool. The BACnet® Setting Tool is dedicated software to set network settings and settings related to BACnet® communication (also including object selection and COV/Event notification) and then set the settings to the AE-200. This manual describes the setting procedures for those settings.

## 1-1. Screen images used in this manual

Screen images used in this manual are from Microsoft® Windows® 7. The layout of screens for software other than the BACnet® Setting Tool (e.g., installation screens) that are displayed in this Instruction Book may differ depending on factors such as the settings of the PC used.

### Registered trademarks

Windows® is a registered trademark or trademark of Microsoft Corporation in the United States and other countries.

Excel® is a registered trademark or trademark of Microsoft Corporation in the United States and other countries.

BACnet® is a registered trade mark of ASHRAE (American Society of Heating, Refrigerating and Air-Conditioning Engineers, INC.). (“BACnet” is indicated for screens of the BACnet® Setting Tool.)

Other company names and product names appearing in this manual are trademarks or registered trademarks of their respective companies.

## 1-2. BACnet® Setting Tool version

Combinations between the AE-200 version and the BACnet® Setting Tool version are shown.

The BACnet® Setting Tool does not support the AE-200 version of different combinations. Use a BACnet® Setting Tool that supports the AE-200 version.

No.	AE-200 version	BACnet® Setting Tool version
1	Ver. 7.3*–7.4*	3.0.*.*
2	Ver. 7.50–7.70	3.1.*.*
3	Ver. 7.71–7.85	3.2.*.*
4	Ver. 7.9 or later	3.3.*.*

\* Arbitrary integer number (As of December 2016)

## 1-3. PC requirements

The BACnet® Setting Tool runs on a PC.

The PC used for the BACnet® Setting Tool requires the following environment.

Item	Requirement	Remarks
CPU	1 GHz or higher	
Memory	1 GB or more	
HDD space	100 MB or more	C drive
Screen resolution	1024 x 768 or higher	
LAN	1 port (100 BASE-TX)	
OS	Microsoft® Windows® 11 (64bit) *1 Microsoft® Windows® 10 (64bit) *1 Microsoft® Windows® 8.1 (64bit) *1	
Execution environment	Microsoft® .NET Framework 4.8 *2 Minimum system requirements for Windows® 8.1, Windows® 10, or Windows® 11 must be met.	
Others	Pointing device such as a mouse Internet connection environment (required when installing .NET Framework)	

\*1 Verified to work on the Pro edition

\*2 When installing the BACnet Setting Tool, the page will jump to the download site if .NET Framework 4.8 or later is not installed.

Note: The use of the latest version of the OS is recommended.

# 1-4. Connection method

The BACnet® Setting Tool connects with the AE-200 using a LAN. \*1  
 Connect the PC with the BACnet® Setting Tool installed to the LAN1 connector of the AE-200 via a HUB (refer to the figure below). For the LAN cable, use a cable that is compatible with category 5 or higher.

\*1 Connect the BACnet® Setting Tool with the AE-200 using IPv4.

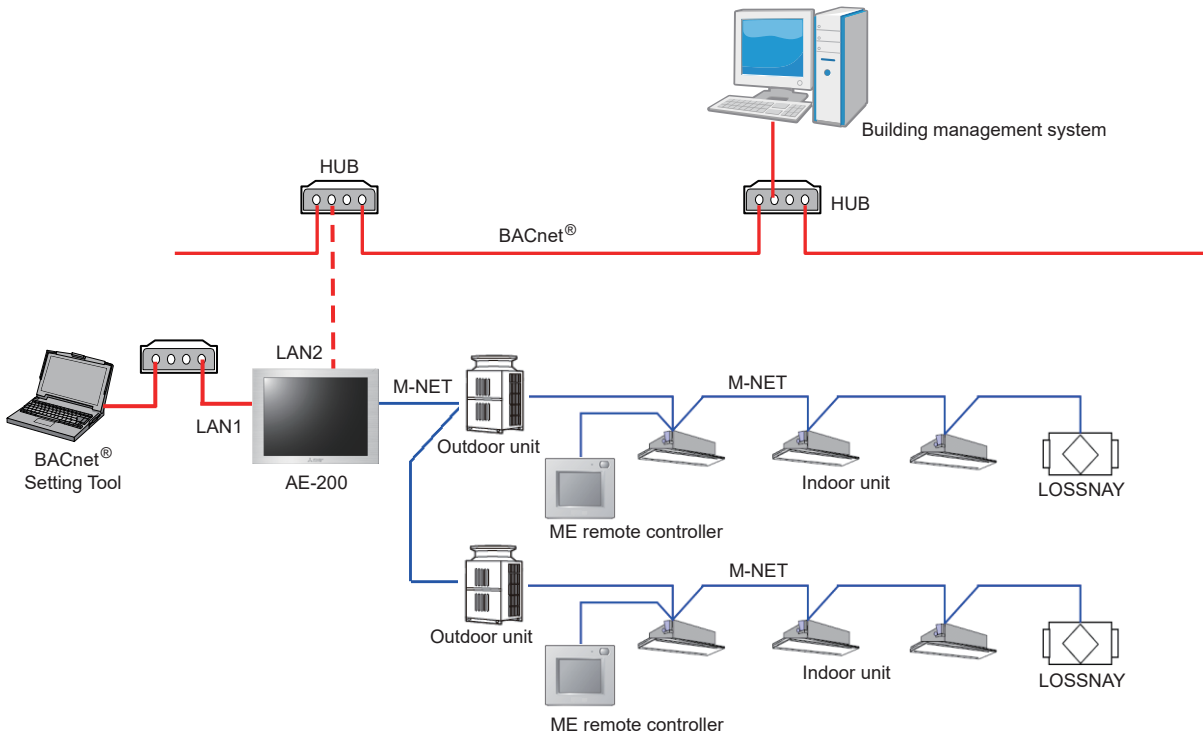

Before performing BACnet® settings for the AE-200 using the BACnet® Setting Tool, it is necessary to set indoor unit group settings on the AE-200 Initial Setting Tool. Refer to section 5-4 “Initial setting procedure” for details. For systems that use multiple AE-200, set all AE-200 connected to BACnet® individually using the BACnet® Setting Tool.

After completion of AE-200 BACnet® settings, connect the AE-200 LAN2 and BACnet®.

- (A) When controlling more than 50 units of equipment and not using an apportioned electricity billing function
- (B) When using an apportioned electricity billing function

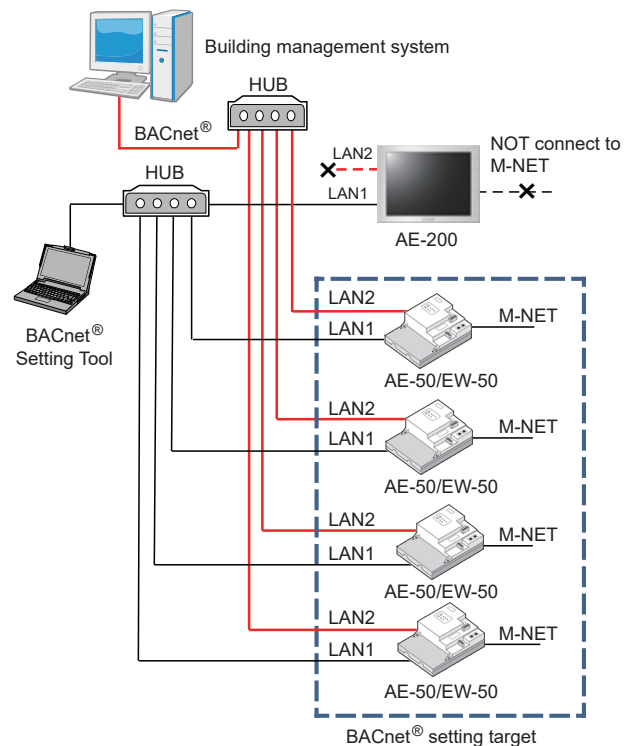
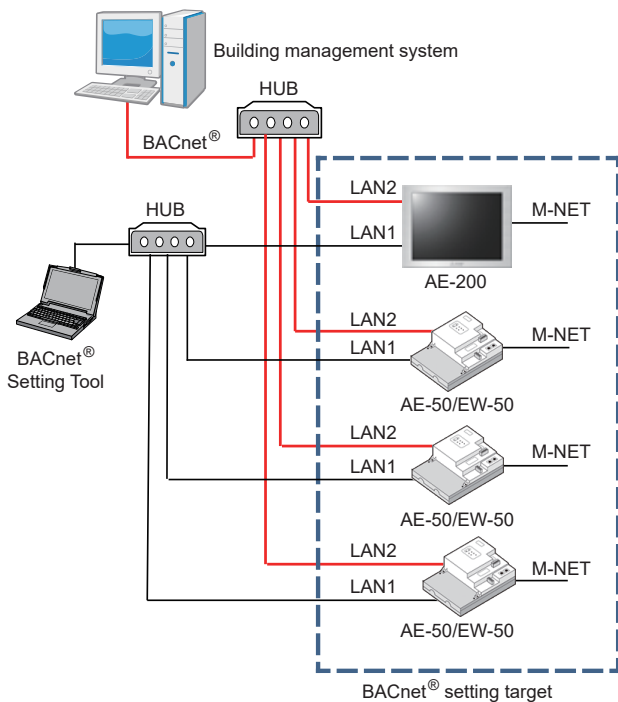

## 2. Setting the Operating Environment

Set the operating environment of the PC to be used for the BACnet® Setting Tool.

### 2-1. Setting the IP address of the PC

Set the IP address of the PC to be used for the BACnet® Setting Tool. Set an IP address for the PC that does not duplicate the IP address of LAN1 of each AE-200 (initial value: 192.168.1.1) but is an IP address of the same network.

For example, when the IP address of LAN1 of the AE-200 is the default value [192.168.1.1] and the subnet mask is the default value [255.255.255.0], set [192.168.1.101] for the IP address of the PC to be used for the BACnet® Setting Tool. In this case, [192.168.1] is the network address.

Connecting terminal	Default value	Remarks
LAN1	192.168.1.1	(Used for air conditioning system)
LAN2	192.168.2.1	(Used for BACnet® communication)

Open the control panel.

Windows® 8.1

Start screen>[Desktop]>[My computer]>[Control panel]

Windows® 10 or 11

Search for the control panel using the search box.

(1) Click [Control Panel] in the Start menu.

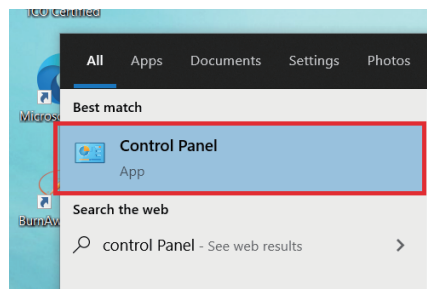

(2) In the [Control Panel] window, click [View network status and tasks].

\* Select "Category" in "View by."

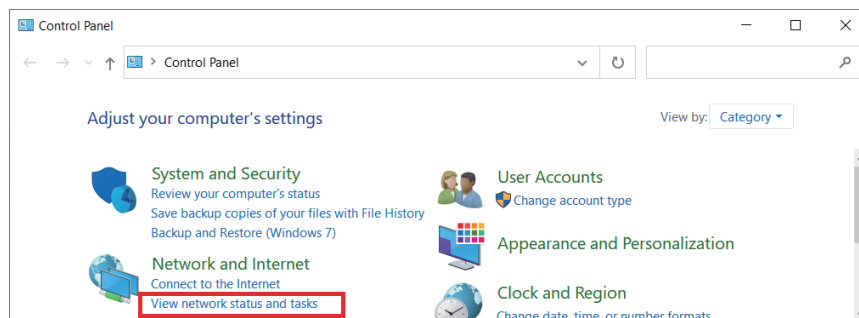

(3) In the [Network and Sharing Center] window, click [Change adapter settings].

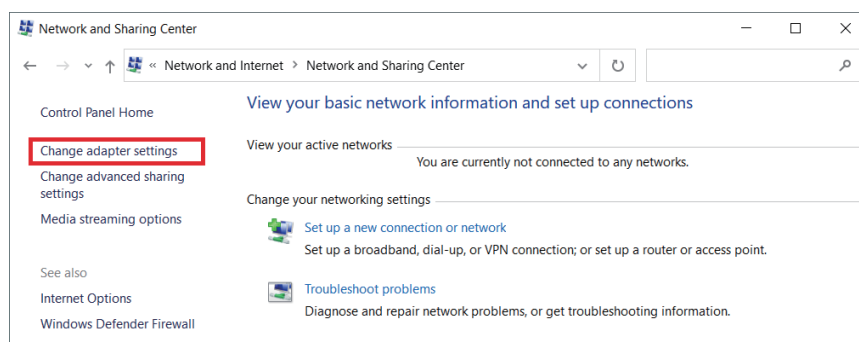

(4) In the [Network Connections] window, double-click the [Ethernet] icon.

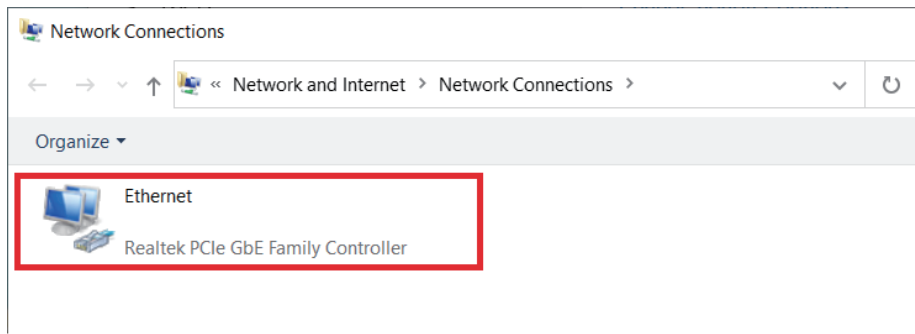

(5) In the [Ethernet status] window, click [Properties].

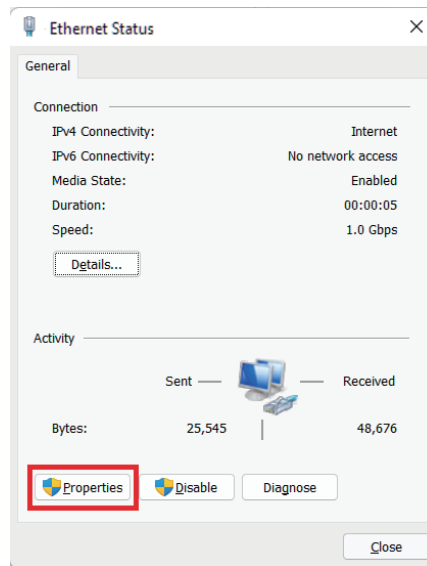

(6) In the [Ethernet Properties] window, click [Internet Protocol Version 4 (TCP/IPv4)] to select it, and click [Properties].

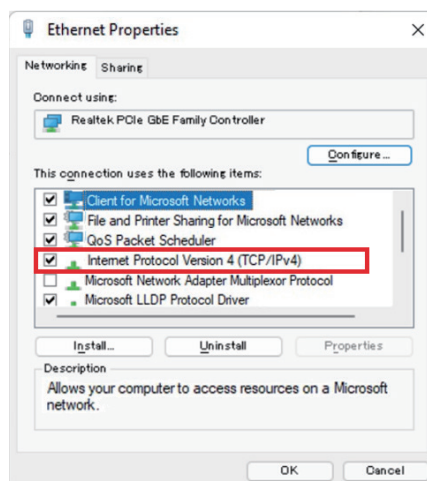

- (7) In the [Internet Protocol Version 4 (TCP/IPv4) Properties] window, check the radio button next to [Use the following IP address].  
Enter the IP address (e.g., [192.168.1.101]) in the [IP address] field, and enter the subnet mask (e.g., [255.255.255.0]) in the [Subnet mask] field.

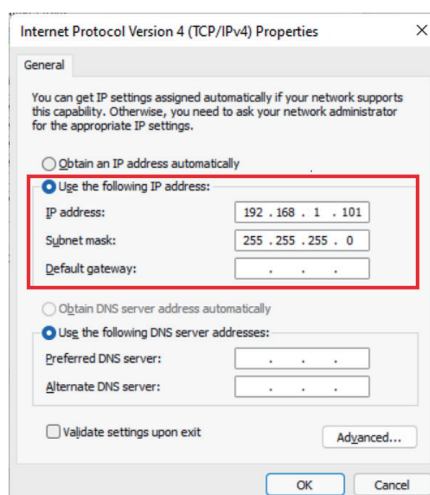

- (8) Keep clicking [OK] or [Close] to close all windows.



## 2-2. Disabling a proxy server

Configure the settings for the IP connection environment of the PC (disable a proxy server).

- (1) Open the Network and Sharing center as follows.

Windows® 8.1

Start screen>[Desktop]>[My computer]>[Control panel]>[Network and Sharing center]

Windows® 10 or 11

Search for the control panel using the search box, and click [Network and Sharing].

- (2) Click [Internet options].

- (3) In the [Internet Options] window, click the [Connections] tab.

Check the radio button next to [Never dial a connection] in the middle of the window, and click [LAN settings] under [Local Area Network (LAN) settings].

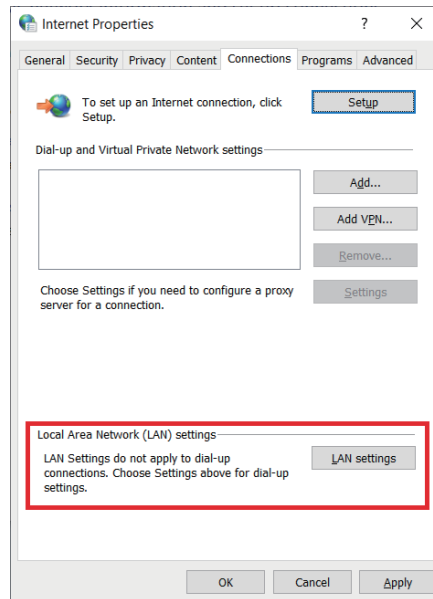

- (4) In the [Local Area Network (LAN) Settings] window, remove the check from the checkbox next to [Use a proxy server for your LAN] under [Proxy server].

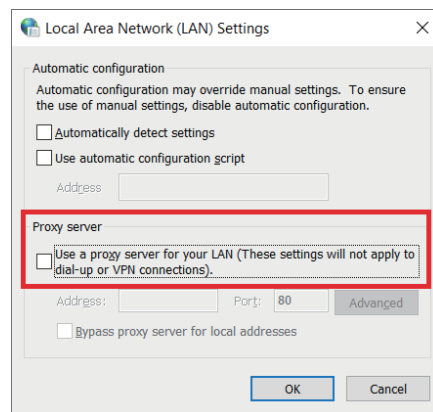

- (5) Keep clicking [OK] or [Close] to close all windows.

## 2-3. Installing .NET Framework

- (1) Click [Control Panel] in the Start menu, click [Programs and Features], and check the version of the Microsoft® .NET Framework.

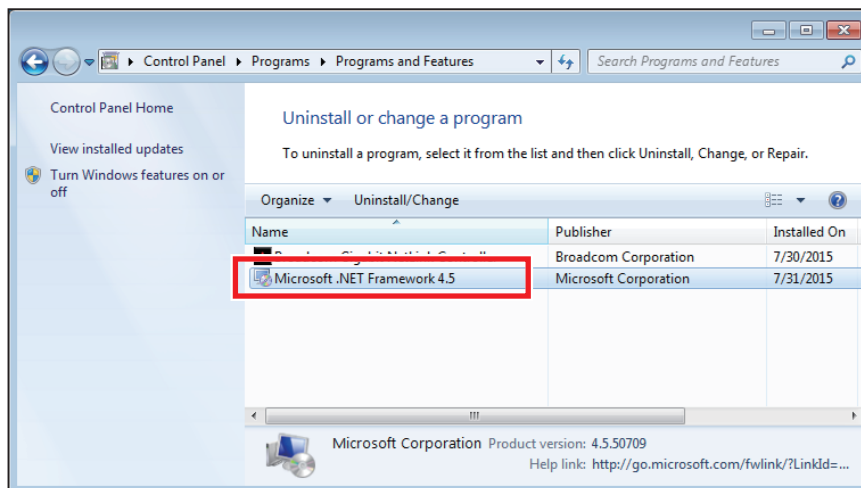

- (2) If .NET Framework 4.8 is not already installed, download the .NET Framework 4.8 installer from the URL shown below, and then install it.

<https://dotnet.microsoft.com/en-us/download/dotnet-framework/net48>

# 3. Installation and uninstallation of BACnet® Setting Tool

This chapter explains how to install the BACnet® Setting Tool (SetBACnet) to a PC and how to uninstall it. If you click [Cancel] in any of the steps during the installation or uninstallation, the installation or uninstallation will be canceled. Also, to return to the previous screen, click [Back].

## 3-1. Installation

### (1) Starting the setup program

Double click the Integration Installer for AE-200 \*1. When setting the AE-200 BACnet® functions, the following two types of setting tool are required.

- AE-200 BACnet® Setting Tool
- AE-200 Initial Setting Tool

Select the check box (  ) for the setting tool to install, then click [Install].

Clicking [Install] will run the installer for the selected setting tool.

\*1 The name of the installer for North America is “AE-200AToolInstaller\_V\*\*\*.exe”, and for Europe is “AE-200EToolInstaller\_V\*\*\*.exe”.

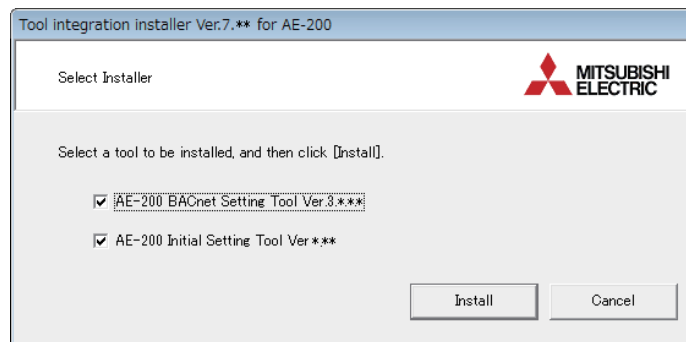

The following details the BACnet® Setting Tool installer. Refer to the AE-200 Instruction Book (Initial Settings) for how to set up the AE-200 Initial Setting Tool.

### (2) Starting the BACnet® Setting Tool setup program

Read the displayed information, and click [Next] to proceed.

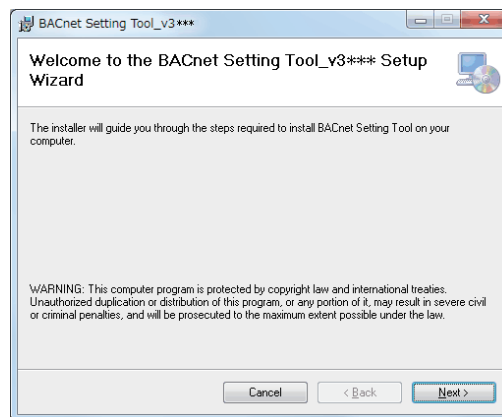

### (3) License agreement

Read the license agreement, select [I Agree] to accept the terms, and click [Next].

\* If you do not agree to the terms of the license, click [Cancel] to cancel the installation.

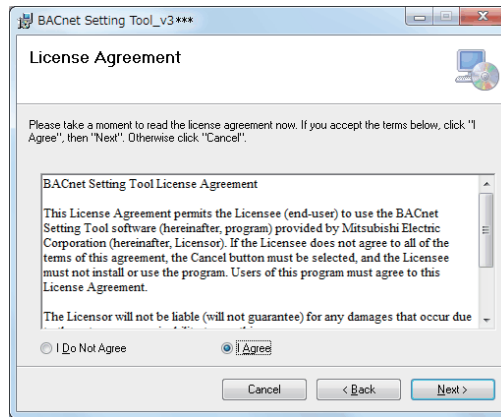

### (4) User information

Enter the user name and the company name, and click [Next].

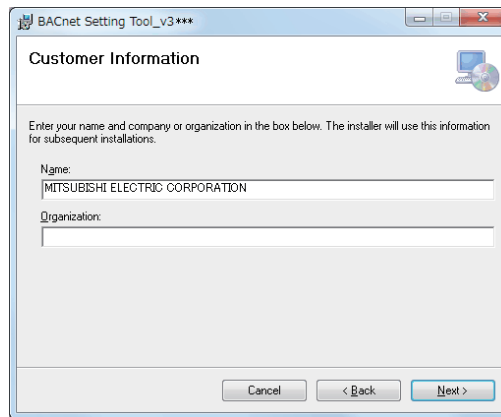

### (5) Selecting the installation destination folder

Select the folder in which to install the program.

Click [Browse...] to select a different installation destination folder.

When done selecting the folder, click [Next] to proceed.

The default installation destination folder location is [C:\Program Files\MITSUBISHI ELECTRIC CORPORATION\AE-200 BACnet Setting Tool\Ver.\*\*\*\*\*]. \*1

Clicking [Disk Cost...] will display the disk capacity of each drive of the PC.

\*1 "Ver.\*\*\*\*\*" indicates the version number of the BACnet® Setting Tool.

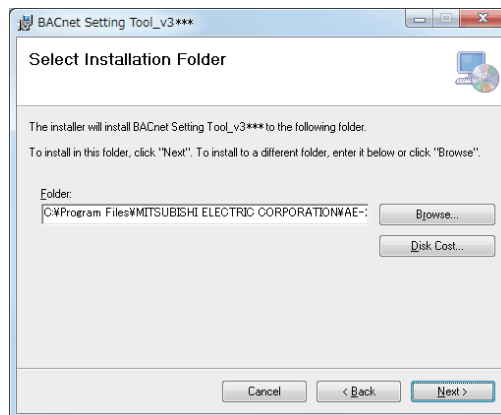

## (6) Executing the installation program

Click [Next] to execute the installation program.

Click [Cancel] to cancel the installation.

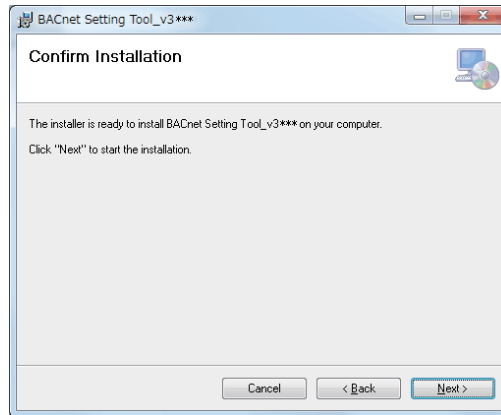

## (7) Confirming completion of installation

Click [Close] on the window to complete the installation process.

Check that the "AE-200\_SetBACnet\_v\*\*\*\*" icon (  ) is displayed in the start menu.

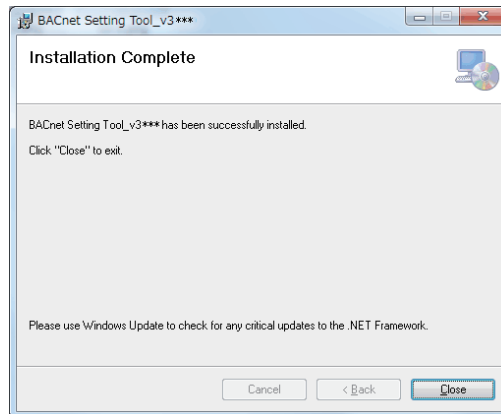

### 3-2. Uninstallation

Take the following steps to uninstall the BACnet<sup>®</sup> Setting Tool (SetBACnet). (Uninstallation is usually not necessary.)

- (1) Ensure that the BACnet<sup>®</sup> Setting Tool (SetBACnet) is not running. Quit the program if it is.
- (2) Click [Control Panel] in the Start menu, and click [Uninstall a program].

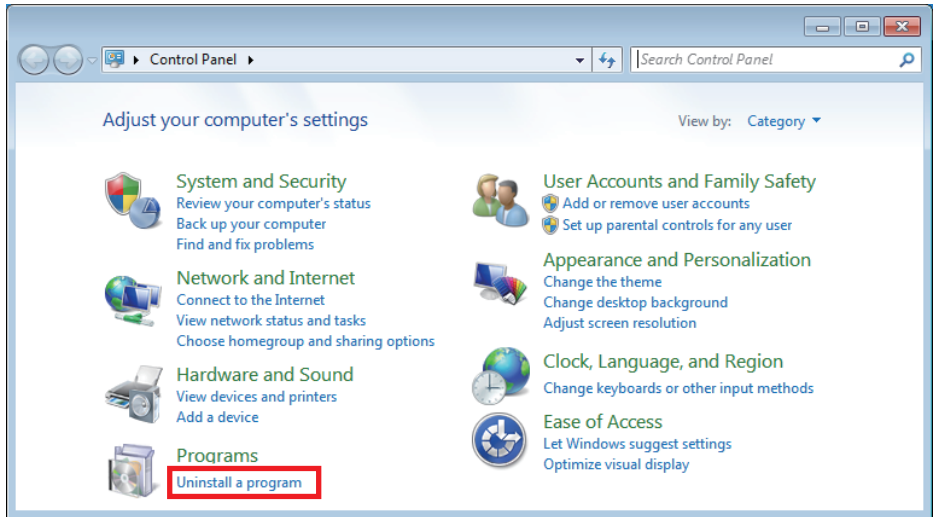

- (3) In the [Programs and Features] window, click [BACnet Setting Tool\_v\*\*\*\*] to uninstall it. Or, click [BACnet Setting Tool\_v\*\*\*\*], right-click, and select [Uninstall].

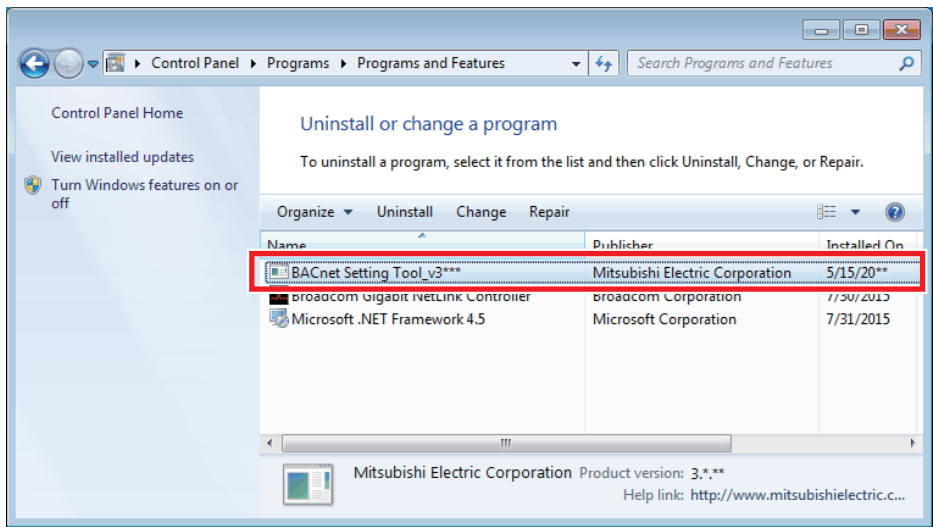

## 4. Connecting and starting up the BACnet<sup>®</sup> Setting Tool

### 4-1. Connecting the BACnet<sup>®</sup> Setting Tool

The BACnet<sup>®</sup> Setting Tool communicates with the AE-200 using a LAN.

Before connecting the BACnet<sup>®</sup> Setting Tool to the AE-200, first disconnect the AE-200 from BACnet<sup>®</sup> (check that a cable is not connected to LAN2). Then, connect LAN1 and the PC with the BACnet<sup>®</sup> Setting Tool installed using a LAN cable.

The BACnet<sup>®</sup> Setting Tool can only be connected to a single AE-200 at a time. Accordingly, when using a configuration that connects multiple AE-200 units, configure BACnet<sup>®</sup> settings for each AE-200.

- **Before configuring the settings of the BACnet<sup>®</sup> function, configure the group settings and the apportioned electricity billing function settings (only when used) with the Initial Setting Tool of the AE-200 unit.**
- **When the IP address of AE-200 overlaps the IP address of another machine inside the network, not only can AE-200 not carry out BACnet<sup>®</sup> communication normally but other devices also cannot carry out BACnet<sup>®</sup> communication normally. Check that the IP address used on AE-200 is configured correctly before connecting AE-200 to BACnet<sup>®</sup>.**
- **When the settings are changed with the BACnet<sup>®</sup> Setting Tool, if the AE-200 BACnet<sup>®</sup> connection mode is changed to [Offline], the monitoring and operation of the AE-200 with the central monitoring device may become no longer possible and a communication error or other alarm may be detected by the central monitoring device so contact the system administrator in advance.**

## 4-2. Starting up the BACnet® Setting Tool

Double-click the BACnet® Setting Tool icon (AE-200\_SetBACnet\_v\*\*\*\*) to start up the BACnet® Setting Tool shown in the figure on the left below.

Select [New Settings] from [File] in the menu bar or select [Acquire settings] from [AE-200/AE-50/EW-50] in the menu bar to display the screen shown in the figure on the right below.

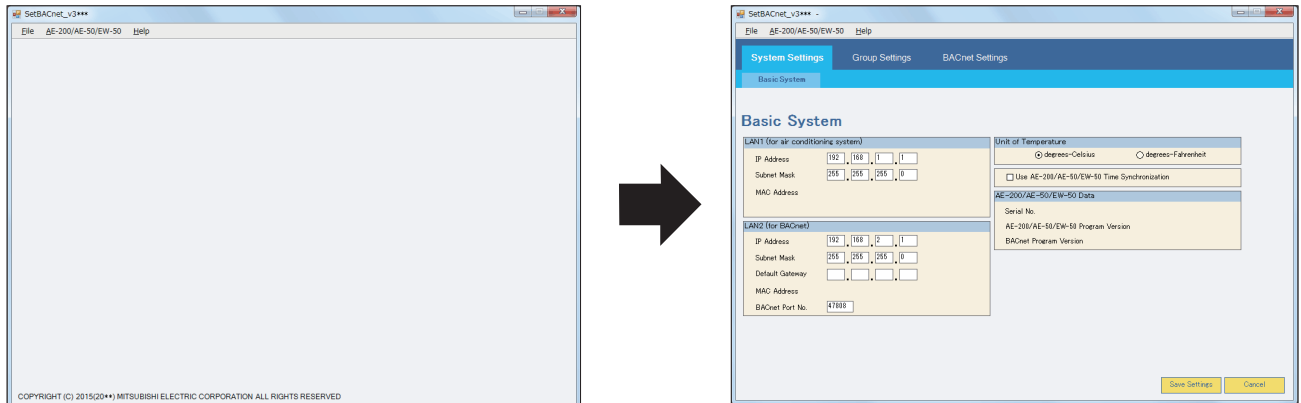

If [Acquire settings] is selected when the BACnet® Setting Tool (PC) is not connected with the AE-200 unit or when a connection is not established, a communication error pop-up screen as shown below appears after approximately 30 seconds.

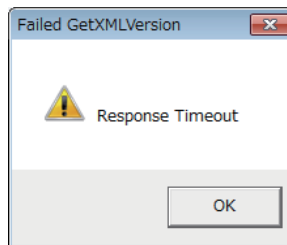

If a communication error occurs, check the following.

- Is the AE-200 running (about 10 minutes is required to complete the start-up process of AE-200)?
- Is the cable between the PC and AE-200 (LAN1) connected correctly?
- Is the IP address of the PC set to an IP address of the same network as LAN1 of the AE-200? (Refer to 2-1 “Setting the IP address of the PC” for details.)
- Does the destination IP address setting of the BACnet® Setting Tool match the IP address of LAN1 of the AE-200? (Refer to 7-2-1 “Property” for details.)



### 4-3. Exiting the BACnet® Setting Tool

To exit the BACnet® Setting Tool, click  at the top right of the BACnet® Setting Tool screen or select [Exit] from [File] in the menu bar.

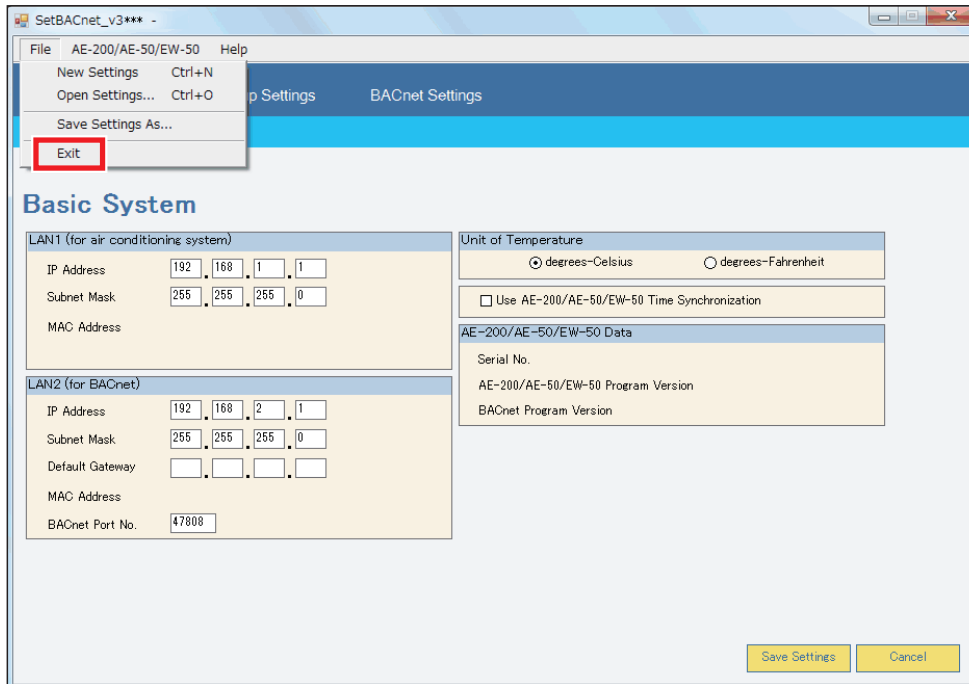

# 5. BACnet<sup>®</sup> Setting Tool screens and setting items

## 5-1. Screen configuration

The screen configuration of the BACnet<sup>®</sup> Setting Tool is shown below. Switch between settings screens by selecting the menu bar, main tab, and sub tab.

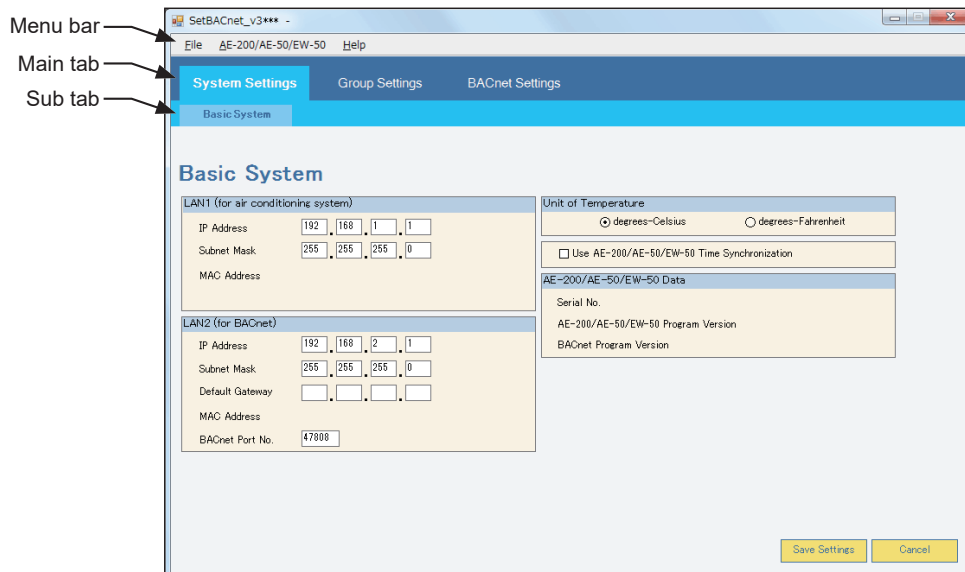

## 5-2. Menu bar configuration

Setting and operation items available from the menu bar are shown below.

Menu	Sub menu	Setting and operation items
File	New Settings	Displays the settings screen for when making new settings.
	Open Settings...	Opens a saved settings data file, and reflects this settings data in the BACnet <sup>®</sup> Setting Tool.
	Save Settings As...	Saves BACnet <sup>®</sup> Setting Tool settings data after first specifying the save folder and file name.
	Exit	Exits the BACnet <sup>®</sup> Setting Tool.
AE-200/AE-50/ EW-50	Property	Sets the LAN1 IP address for the AE-200 to communicate with.
	Acquire settings...	Acquires the settings data from the AE-200.
	Send settings...	Sends the settings data to the AE-200.
	Mode Setting	Sets the BACnet <sup>®</sup> connection mode (Online/Offline).
	Date and Time	Sets the current date and time in the AE-200.
Help	About	Displays the version number of the BACnet <sup>®</sup> Setting Tool.
	Instruction Book <PDF>	Opens the BACnet <sup>®</sup> Setting Tool Instruction Book (this manual) in PDF format.

### 5-3. Setting tab configuration

Settings screens that are selected in the main tab and sub tab are as follows, and the items that can be set on each settings screen are as below.

Main tab	Sub tab	Setting items
System Settings	Basic System	Sets IP address information for AE-200 LAN1 (for air conditioning) and LAN2 (for BACnet <sup>®</sup> connection), and time synchronization for air conditioning unit to connect. This also displays the AE-200 serial number, AE-200 program version, and the BACnet <sup>®</sup> program version.
Group Settings	Group	Displays group settings for the air conditioning unit, remote controller, and system controller. <b>Group information cannot be changed from the BACnet<sup>®</sup> Setting Tool. Configure group settings from the AE-200 Initial Setting Tool.</b> Refer to the Instruction Book (BACnet <sup>®</sup> Setting Tool) for the setting method.
BACnet Settings	BACnet	Sets BACnet <sup>®</sup> settings including AE-200 device numbers, device names, APDU settings, I-Am transmission periods; air conditioning unit settings including dry mode usage Y/N, fan speed Mid1/Mid2 usage Y/N, and operation mode status automatic display Y/N.
	Network and Device	Registers notification destination devices for COV and EVENT notifications.
	COV Notification	Registers device number, process ID, and notification type (with confirmation, without confirmation) for COV Notification destinations.
	Event Notification	Registers device number, process ID, and notification type (with confirmation, without confirmation) for Event Notification destinations.
	Object	Selects the object to use, the requirement for COV/Event Notification and the notification destination, and sets the Event Notification (Event_Enable, Notify_Type).
	Other	Set the notification destination at reset.
	ForcedOff Reset	Used when using the Settings Tool to cancel an AE-200 emergency stop originating from the central monitoring device (BACnet <sup>®</sup> ). Settings not required.

## 5-4. Initial setting procedure

Initial settings procedures for the AE-200 are shown below.

First, from procedures ①, ②, and onwards in the work flow below, make the basic settings for AE-200 and air conditioning system unit settings using the AE-200 Initial Setting Tool, AE-200's LCD, or Web browser for Initial Settings. For details, refer to Table 5-4 below and AE-200 Instruction Book (Initial Settings).

Carry out initial settings for BACnet® functions from ③ onwards in the work flow below. For initial settings for BACnet® functions from ③ onwards, refer to 5-4-1 "BACnet® function initial settings flow" and 5-4-2 "Initial settings procedure using the BACnet® Setting Tool".

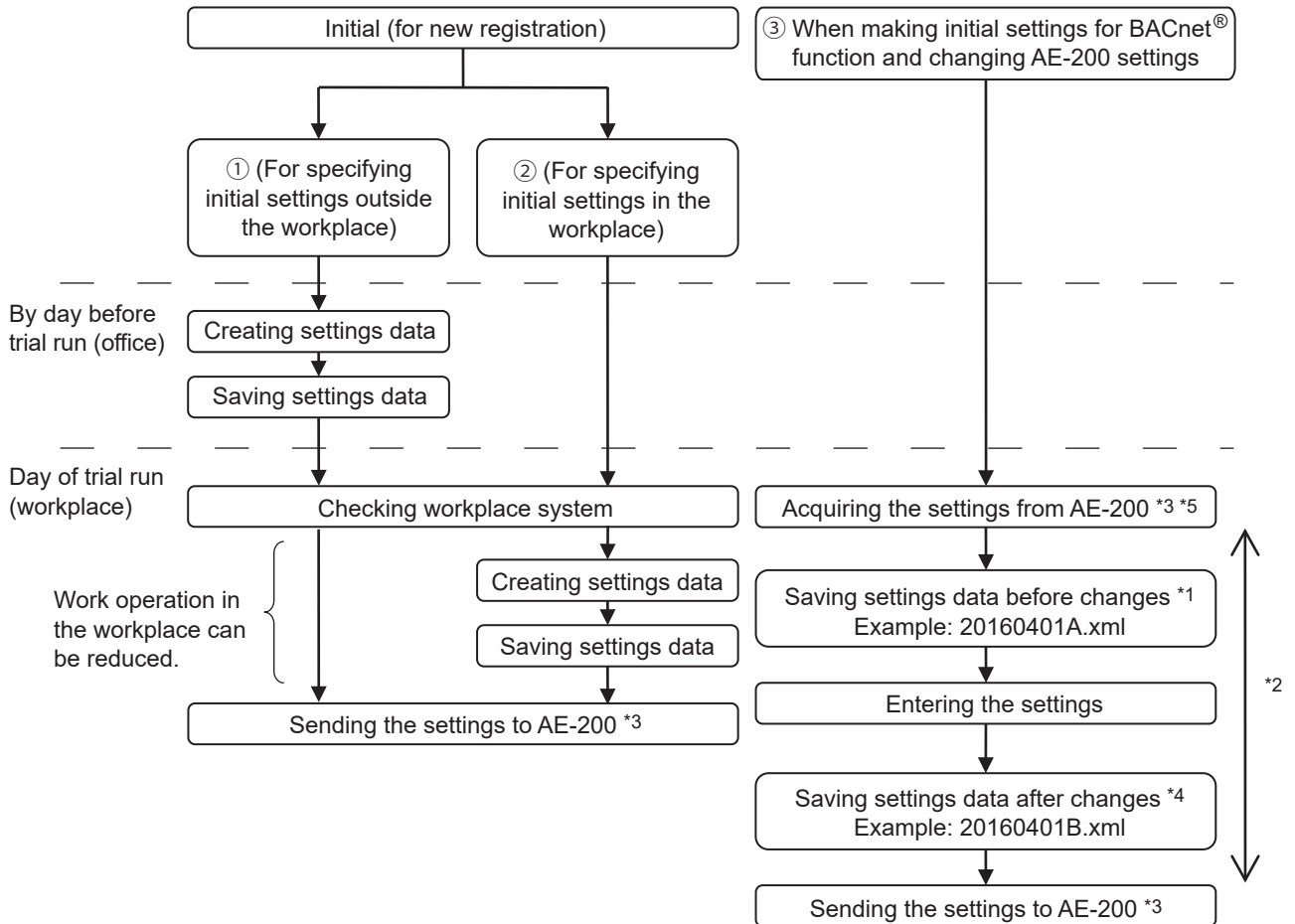

\*1 When changing existing AE-200 settings, ensure that you save the settings details (xml file) before the change is done.

\*2 After acquiring the settings data using the BACnet® Setting Tool and making changes to the settings, do not change settings from the AE-200 Initial Setting Tool, the AE-200's LCD, or the web browser until sending of the changed data has completed.

\*3 Settings data created using the BACnet® Setting Tool cannot be written to, or read from the AE-200 using USB memory.

\*4 Ensure that you store the settings file (settings data before and after changes) configured using the BACnet® Setting Tool.

\*5 Before changing the settings of the existing AE-200, AE-50, or EW-50, acquire the settings data from AE-200. If the settings are changed without obtaining the settings data, the data on the unit may be overwritten with the wrong data.

Table 5-4. Basic settings items for AE-200 using the AE-200 Initial Setting Tool, AE-200's LCD, or Web Browser for Initial Settings

(V: Settable/—: Not settable)

Setting items		Initial Setting Tool	AE-200's LCD	Web Browser for Initial Settings
Basic Settings	Network	—	√	√
	Unit information *1	√	√	√
	License registration *3	√	√	√
	System configuration	√	—	—
	Basic system *1	√	√	√
Unit Settings	Group	√	√	√
	Refrigerant system *2	√	—	—
	Interlocked LOSSNAY	√	√	√
	Block	√	√	√
	Energy management block *2	√	√	—
	PI controller	√	√	√
	AI controller	√	√	√

\*1 Settable items vary with the initial settings method (Initial Setting Tool, AE-200's LCD, or Web Browser for Initial Settings).

\*2 These items must be set when an apportioned electricity billing function is used.

\*3 Licenses can also be registered on the Integrated Centralized Control Web.

### 5-4-1. BACnet<sup>®</sup> function initial settings flow

After performing the initial setting of air conditioning system in the AE-200 using the AE-200 Initial Setting Tool, AE-200/AE-50's LCD, or Web Browser for Initial Settings, perform the following AE-200 BACnet<sup>®</sup> function settings. Refer to this manual for detailed procedures and settings details for AE-200 BACnet<sup>®</sup> settings. (Group settings cannot be configured from the BACnet<sup>®</sup> Setting Tool. Carry out settings from the AE-200 Initial Setting Tool or AE-200's LCD.)

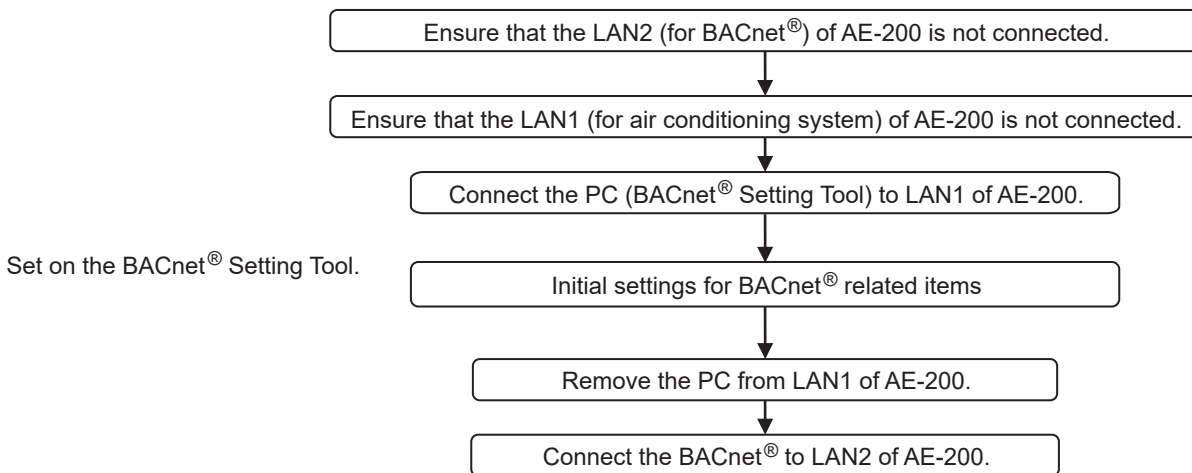

## 5-4-2. Initial settings procedure using the BACnet® Setting Tool

Perform initial BACnet® settings using the BACnet® Setting Tool, using the following procedure.

(“No.” in the following table indicate the steps.)

No.	BACnet® Setting Tool	Setting items
1	Menu bar [AE-200/AE-50/EW-50] — [Property]	IP address of LAN1 (for air conditioning system) of AE-200 (Refer to 7-2-1.)
2	[AE-200/AE-50/EW-50] — [Mode Setting] (“Offline”)	Set to [Offline]. (Refer to 7-2-4.)
3	[AE-200/AE-50/EW-50] — [Acquire settings]	(Refer to 7-2-2.)
4	Tab System Settings — Basic System	Set the IP addresses of LAN1 and LAN2. (Refer to 8-2-1.)
5	BACnet Settings — BACnet	Register the AE-200 device number. (Refer to 8-4-1.)
6	BACnet Settings — Network and Device	Register other devices to be connected to BACnet®. (Refer to 8-4-2.)
7	BACnet Settings — COV Notification	Set the COV No. and notification address. (Refer to 8-4-3.)
8	BACnet Settings — Event Notification	Set the notification class and notification address. (Refer to 8-4-4.)
9	BACnet Settings — Object	Select the objects to be used and configure the notification settings for each object. (Refer to 8-4-5.)
10	Menu bar [File] — [Save Settings As...]	(Refer to 7-1-4.)
11	[AE-200/AE-50/EW-50] — [Send settings]	(Refer to 7-2-3.)
12	[AE-200/AE-50/EW-50] — [Mode Setting] (“Online”)	Set to [Online]. (Refer to 7-2-4.)
13	[AE-200/AE-50/EW-50] — [Mode Setting] (Confirm)	Ensure that [Online] is set. (Refer to 7-2-4.) *1

\*1 After performing [Send settings] to the AE-200, check the followings.

- ① Perform [Acquire settings] and check that the data has been properly set.
- ② Check that the AE-200 BACnet® connection mode is “Online”.

## 6. Saving settings data

### 6-1. Settings data flow

The figure below shows the flow image of the settings data when the BACnet<sup>®</sup> Setting Tool is used.

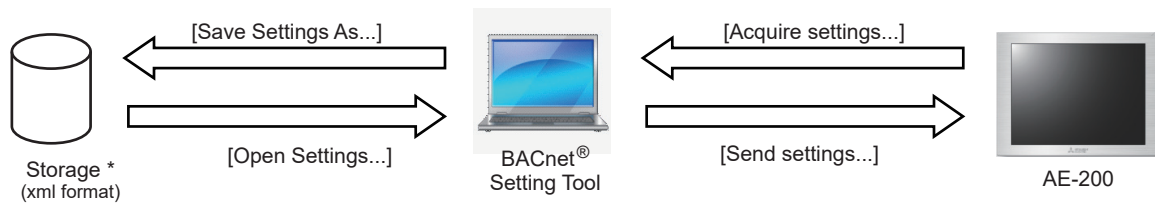

\* HDD, USB memory, etc. for the BACnet<sup>®</sup> Setting Tool PC

Note: Before changing the settings of the existing AE-200, AE-50, or EW-50, acquire the settings data from AE-200. If the settings are changed without obtaining the settings data, the data on the unit may be overwritten with the wrong data.

Settings data includes all data that can be displayed or set using the BACnet<sup>®</sup> Setting Tool, however the following are exceptions.

- Items that can be set from the menu [AE-200/AE-50/EW-50] (destination IP address, BACnet<sup>®</sup> connection mode, current time) are not included in settings data.

### 6-2. Backing up settings data

Ensure that backup data of settings data is kept on external storage for use in the event of recovering from an AE-200 failure. Additionally, store this on the internal HDD of the BACnet<sup>®</sup> Setting Tool PC.

The saved .xml format settings information data can be applied to the AE-200 by going to the menu bar and selecting [Open Settings...], then opening the BACnet<sup>®</sup> Setting Tool and selecting [Send settings...].



## 7. Menu bar

The menu bar has three items — [File], [AE-200/AE-50/EW-50], and [Help].

### 7-1. File

Use [File] menu for the following operations and settings.

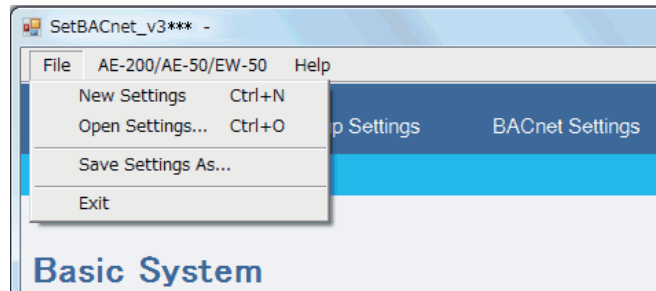

#### 7-1-1. New Settings

Used to create new settings information. Displays the initial status settings screen (displays default values for screen). The initial status is the same as the factory default settings for the AE-200.

#### 7-1-2. Open Settings

Used when opening a settings data file in BACnet<sup>®</sup> Setting Tool. Select the saved file name, click [Open Settings] to open the file and display settings details on the settings screen.

Note: An error message "XML Version is not right value." will appear if the version of the BACnet<sup>®</sup> Setting Tools is old. Refer to section 1-2 "BACnet<sup>®</sup> Setting Tool version" for version compatibility.

#### 7-1-3. Save Settings As...

Specify the save folder, input the file name, and click [Save] to save the settings details as an xml format file (with ".xml" file extension).

#### 7-1-4. Exit

Closes the BACnet<sup>®</sup> Setting Tool. When settings details have been changed, before closing the BACnet<sup>®</sup> Setting Tool, ensure that this has been saved using [Save Settings As...], and save the settings data file (xml format).

## 7-2. AE-200/AE-50/EW-50

Use [AE-200/AE-50/EW-50] menu for the following operations and settings.

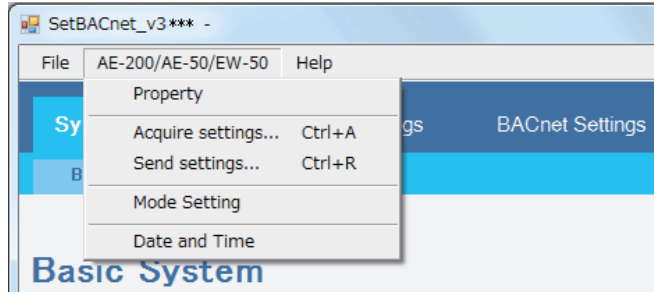

### 7-2-1. Property

Input the LAN1 IP address of the AE-200 that is the BACnet® Setting Tool destination, and click [OK] to set. Set the port number to 80 (fixed).

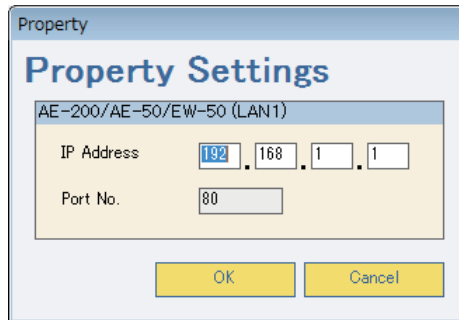

### 7-2-2. Acquire settings

Uses the BACnet® Setting Tool to acquire the settings data set for the AE-200, and displays this on the BACnet® Setting Tool screen. When changing current settings data, ensure that you select [Acquire settings] to read the settings data before editing. Furthermore, if you select [Acquire settings] during editing of settings data, then this will discard the data being edited, and refresh using the data acquired from the AE-200. Therefore, if it is necessary to save data that is being edited, then save the data before selecting [Acquire settings].

### 7-2-3. Send settings

Sets settings data created on the BACnet® Setting Tool on the AE-200. [Send settings] cannot be selected when the AE-200 BACnet® connection mode is [Online], therefore temporarily set the AE-200 BACnet® connection mode to [Offline] before selecting [Send settings].

**Switching the AE-200 BACnet® connection mode from [Offline] to [Online] will restart the AE-200. (Refer to 7-2-4 “Mode Setting” for switching Offline/Online and for display of current situation.)**

Additionally, selecting [Send settings] will update the settings data stored in the AE-200 with that from the BACnet® Setting Tool. If there is no backup data for the settings data stored in the AE-200, then perform a backup before selecting [Send settings], and save the settings data stored in the AE-200 as below.

<<Method to backup settings data stored in the AE-200>>

- (1) Use [Save Settings As...] to save the data (a) set in the BACnet® Setting Tool (a.xml).
- (2) Use [Acquire settings] to acquire the settings data (b) stored in the AE-200.
- (3) Use [Save Settings As...] to save the acquired data (b) (b.xml).
- (4) Use [Open Settings] to read the settings data (a) (a.xml) into the BACnet® Setting Tool.
- (5) Use [Send settings] to reflect the data (a) to the AE-200.

Note: If an error message “Version Mismatch Error The version of this tool is not compatible with the version of AE-200/AE-50/EW-50” pops up after [Send settings] is executed, refer to section 1-2 “BACnet® Setting Tool version” for version compatibility.

## 7-2-4. Mode Setting

Sets the AE-200 BACnet<sup>®</sup> connection mode (Online/Offline). When switching the connection mode from [Offline] to [Online], the AE-200 will automatically restart.

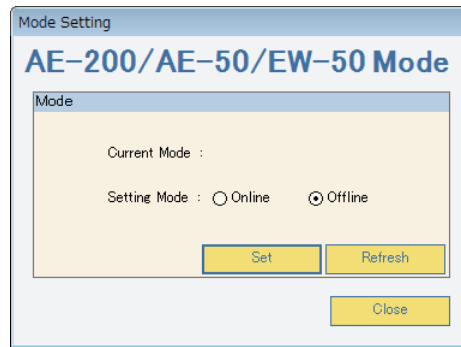

Online: The AE-200 is communicating with the central monitoring device (BACnet<sup>®</sup>)

Offline: The AE-200 is disconnected from the central monitoring device (BACnet<sup>®</sup>)

When performing [Send settings] to the AE-200, set to [Offline].

\* Important notes when selecting [Acquire settings] or [Send settings]

- (1) Select [Send settings] after switching the AE-200 BACnet<sup>®</sup> connection mode to [Offline].
- (2) If [Send settings] is selected when [Online], then the BACnet<sup>®</sup> Setting Tool will display an error, and abort [Send settings].
- (3) To close [Send settings] and return to the normal AE-200 operational status, switch to [Online].
- (4) After switching to [Online], the AE-200 will restart.
- (5) **After restart, check that the AE-200 BACnet<sup>®</sup> connection mode is [Online].**  
Completion of start-up can be confirmed by either the AE-200's LCD operating, or by being able to connect using a web browser.
- (6) If the AE-200 is [Offline], then BACnet<sup>®</sup> communications are stopped. When using the central monitoring device to monitor the status of devices connected to BACnet<sup>®</sup>, the central monitoring device may output an alarm, therefore when switching the AE-200 BACnet<sup>®</sup> connection mode to [Offline], first contact the system administrator.

## 7-2-5. Date and Time

Sets the date and time in the AE-200. By selecting [Date and Time], the BACnet® Setting Tool acquires from the AE-200 the date and time stored in the AE-200. Use [▲]/[▼] to set the current time, then click [Set] to update the date and time saved in the AE-200. Additionally, click [Refresh] to display the current time of the AE-200. If not connected to the AE-200, then use of [▲]/[▼] is not possible.

The screenshot shows a software window titled "Date and Time". Inside the window, there is a sub-window titled "AE-200/AE-50/EW-50 Date and Time". This sub-window contains six spinners for setting the date and time. The top row has spinners for "Day", "Month", and "Year", separated by hyphens. The bottom row has spinners for "Hour", "Minute", and "Second", separated by colons. Below the spinners are three buttons: "Set", "Refresh", and "Close".

Expansion controllers (AE-50/EW-50) and AE-200 whose [Time Master/Sub] setting is set to [Sub] are overwritten once a day with the AE-200 time.

If [Use AE-200/AE-50/EW-50 Time Synchronization] is selected, this will be overwritten with the time on the central monitoring device. Refer to 8-2-1-4 "Use AE-200/AE-50/EW-50 Time Synchronization" for details.

## 7-3. Help

[Help] menu shows the following.

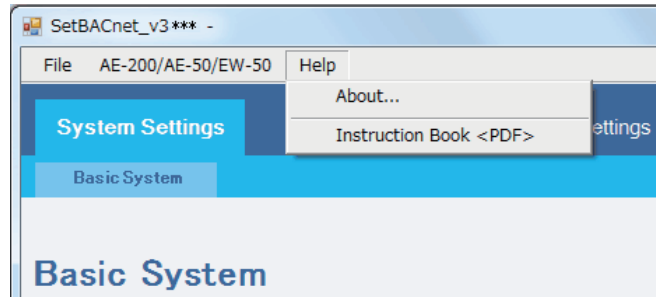

### 7-3-1. About

The BACnet<sup>®</sup> Setting Tool program version is shown in a pop-up window. Click [OK] or  at the upper right to close the window.



Version information is always shown on the title bar of the BACnet<sup>®</sup> Setting Tool window.

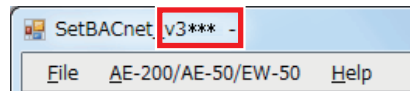

### 7-3-2. Instruction Book <PDF>

When the BACnet<sup>®</sup> Setting Tool is installed on a PC, this Instruction Book in PDF format is also installed to the same folder. If PDF viewing software is already installed, then select [Instruction Book <PDF>] to view this Instruction Book.

# 8. Setting screens

## 8-1. Explanation of Screen Buttons

This explains what operations occur when screen buttons are pressed.

### 8-1-1. Tab screen

The following shows the sample of the Setting Tool screen.

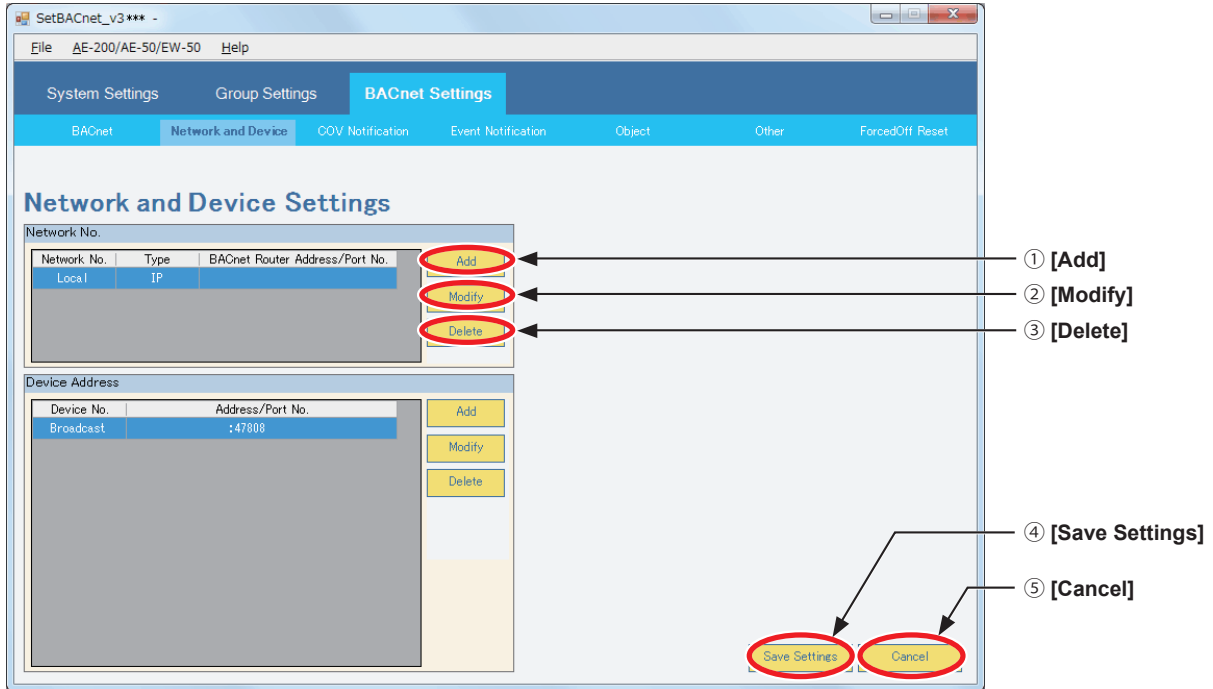

<Sample tab screen that shows buttons>

	Button	Description
①	Add	Click to add a setting.
②	Modify	Click to change the selected setting.
③	Delete	Click to delete the selected setting. When clicked, a popup window as shown below appears. <div data-bbox="769 1355 1149 1563" data-label="Image"> </div> [Yes]: Deletes the selected setting. [No]: Returns to the settings screen without making any changes.
④	Save Settings	Click to temporarily save the displayed settings data. Selecting [Save Settings] enables switching to other tab screens. However, settings details are not sent to the AE-200 at the point [Save Settings] is clicked. After configuring settings, select [Send settings] from the tool bar to send settings details to the AE-200. Refer to 7-2-3 "Send settings" for details. Additionally, the settings file is not saved even after sending the settings data. To save the settings file, select [File], then select [Save Settings As...] from the tool bar.
⑤	Cancel	Click to discard changed settings details currently displayed on the screen, and display the temporarily saved settings details (before change).

## 8-1-2. Pop-up screen

### 8-1-2-1. [OK]

Reflects the settings details in the pop-up window to the BACnet® Setting Tool, and closes the pop-up window.

### 8-1-2-2. [Cancel]

Closes the pop-up window, without reflecting the settings details in the pop-up window to the BACnet® Setting Tool. (The settings screen will return to its previous content.)

## 8-1-3. Screen transition

When changing settings details on each tab screen, click [Save Settings] to temporarily save. When switching to a different tab screen without confirming changed details, the following pop-up window will be displayed.

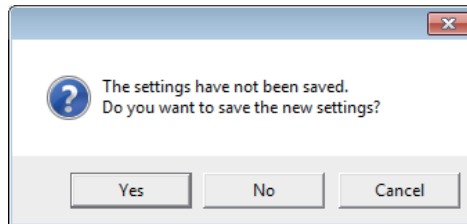

[Yes]: Temporarily saves changed settings details, then switch to the selected tab screen.

[No]: Switches to the selected tab screen without temporarily saving changed settings details.

[Cancel]: Returns to the previous tab screen while displaying the changed details.

## 8-2. System Settings

[System Settings] has the [Basic System] settings screen.

### 8-2-1. Basic System

Set the IP addresses of AE-200 LAN1 (for air conditioning system) and LAN2 (for BACnet®).

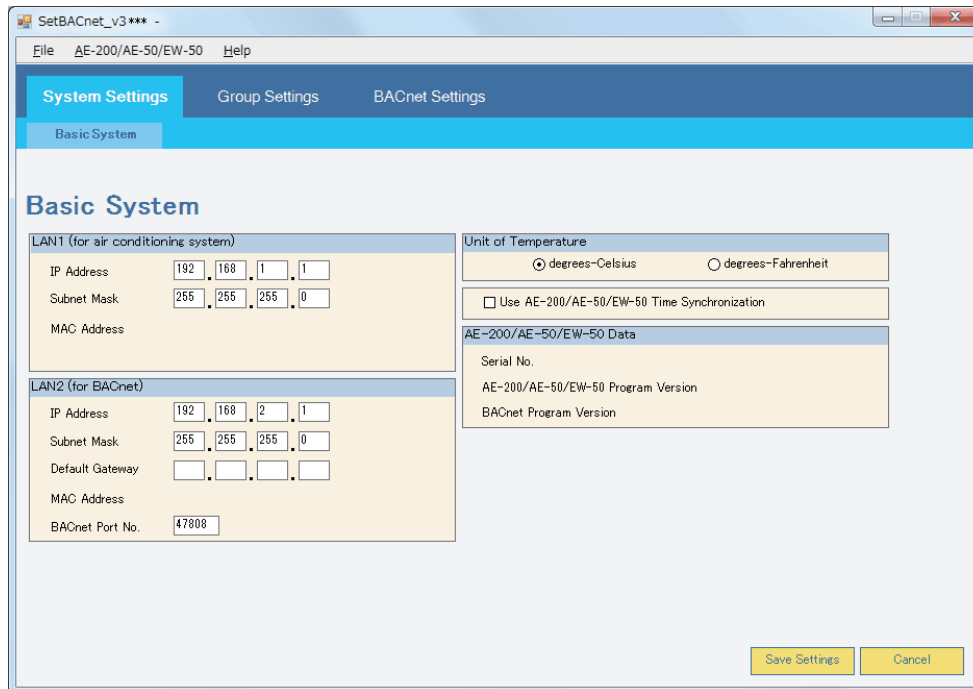

#### 8-2-1-1. LAN1 (for air conditioning system)

Set fields for the LAN1 (for air conditioning system) IP address. LAN1 can only use IPv4.

LAN1 (for air conditioning system)				
IP Address	192	168	1	1
Subnet Mask	255	255	255	0
MAC Address				

No.	Item	Default value
1	IP Address	192.168.1.1 *1*2
2	Subnet Mask	255.255.255.0 *1
3	MAC Address	Displayed when [Acquire settings] is performed.

\*1 Normally, set as in the following table based on the leading octet value of the IP address. (Figures within parentheses indicate the private IP address.)

No.	IP address leading octet value	Subnet mask to set
1	1 to 126 (10)	255. 0. 0. 0
2	128 to 191 (172)	255.255. 0. 0
3	192 to 223 (192)	255.255.255. 0

\*2 LAN1 (for air conditioning system) and LAN2 (for BACnet®) do not support the same network setting. Set a different network address, respectively.

Note: Refer to section 8-2-1-2 "LAN2 (for BACnet®)" for information on default gateway.



### 8-2-1-2. LAN2 (for BACnet®)

Sets fields for the AE-200 LAN2 (for BACnet®) IP address (some items are display-only). LAN2 can only be set using IPv4.

LAN2 (for BACnet)				
IP Address	192	168	2	1
Subnet Mask	255	255	255	0
Default Gateway				
MAC Address				
BACnet Port No.	47808			

No.	Item	Description	Default value
1	IP Address	Set the IP address of AE-200 (LAN2).	192.168.2.1 *1*2
2	Subnet Mask	Set the IP address network address portion (LAN2).	255.255.255.0 *1
3	Default Gateway	When using an IP router for BACnet® communications, set the IP address of the IP router (LAN1, LAN2). *3 *4 If not using an IP router, do not set this.	(Blank)
4	BACnet Port No.	Display the port number used by the AE-200 for BACnet® communications.	47808

\*1 Normally, set as in the following table based on the leading octet value of the IP address. (Figures within parentheses indicate the private IP address.)

No.	IP address leading octet value	Subnet mask to set
1	1 to 126 (10)	255. 0. 0. 0
2	128 to 191 (172)	255.255. 0. 0
3	192 to 223 (192)	255.255.255. 0

\*2 LAN1 (for air conditioning system) and LAN2 (for BACnet®) do not support the same network setting. Set a different network address, respectively.

\*3 Each AE-200/AE-50/EW-50 has two LAN ports (LAN1 and LAN2). Although the connection of network for web browser and network for BACnet® is possible, the connection of network that requires different gateway address settings is not possible. The "Default Gateway" item for LAN2 will be a default gateway for both LAN1 and LAN2 and is not exclusively for LAN2.

\*4 When the rotary switch (SW1) is set to a value other than "0" in the Quick IP address (LAN1) setting of EW-50, the default gateway of LAN1 and LAN2 will be fixed to 0.0.0.0.

**Setting the wrong IP address may impact other devices connected to BACnet®, therefore ensure the IP address used by the AE-200 is set correctly.**

### 8-2-1-3. Unit of Temperature

Select a desired temperature unit to be used. (Default setting: [degrees-Celsius])

Check the radio button next to [degrees-Celsius] to display the temperatures in °C.

Check the radio button next to [degrees-Fahrenheit] to display the temperatures in °F.

### 8-2-1-4. Use AE-200/AE-50/EW-50 Time Synchronization

If reflecting the time data sent from the central monitoring device to the AE-200 or M-NET system (indoor units, remote controllers, or system controllers), select this check box.

(Default value: not selected (do not synchronize time to AE-200 or M-NET system))

<input type="checkbox"/> Use AE-200/AE-50/EW-50 Time Synchronization
--

### 8-2-1-5. AE-200/AE-50/EW-50 Data

AE-200-related data appears when [Acquire settings] is performed.

AE-200/AE-50/EW-50 Data	
Serial No.	05864-234
AE-200/AE-50/EW-50 Program Version	7.**
BACnet Program Version	3.**

**(1) Serial No**

AE-200 serial number appears.

**(2) AE-200/AE-50/EW-50 Program Version**

AE-200 program version appears.

**(3) BACnet Program Version**

AE-200 BACnet® program version appears.

## 8-3. Group Settings

### 8-3-1. Group

Displays the group settings configuration set in the AE-200 Initial Setting Tool, AE-200's LCD, or Web browser (units, remote controllers, and system controllers for each group). (Default status is all fields blank.)

From the [AE-200/AE-50/EW-50] menu, click [Acquire settings] to acquire the group settings set in the AE-200.

(Group settings cannot be changed from the BACnet® Setting Tool.)

Furthermore, when selecting [Send settings] from the BACnet® Setting Tool, the group settings information is not sent to the AE-200.

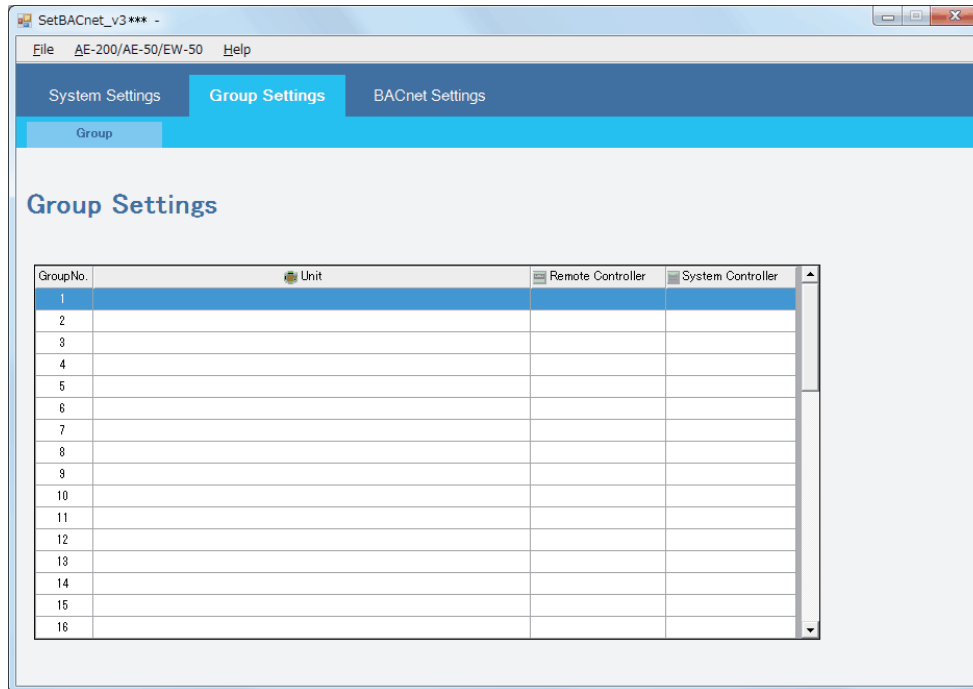

No.	Item	Description
1	Group No.	Group numbers are displayed. (Range of group numbers: 1 to 50)
2	Unit	M-NET addresses of the units (such as air conditioning units and LOSSNAY units) in a given group are displayed.
3	Remote Controller	M-NET addresses of the remote controllers that operate a given group are displayed.
4	System Controller	M-NET addresses of the system controllers that operate a given group are displayed.

## 8-4. BACnet® Settings

[BACnet Settings] has [BACnet], [Network and Device], [COV Notification], [Event Notification], [Object], [Other], and [ForcedOff Reset] settings screens.

The following explains basic terminology used in BACnet®.

<BACnet® terminology>

Terminology	Description
Network No.	Number that identifies the BACnet® router to which BACnet® device (equipment) is connected. In this settings tool, on systems not using the BACnet® router, this is "Local".
Device No.	Number that identifies the BACnet® device (equipment). IP addresses are assigned on a per-device basis.
Object	Information regarding input/output and other internal status of the BACnet® device (equipment).
COV notification	Abbreviation of Change Of Value. Function that notifies other BACnet® devices of changes in the event of a change to an object PresentValue or StatusFlags.
Event notification	Notifications of detected alarms and events based upon algorithms defined in each object.
I-Am	BACnet® services to communicate device information such as device No., APDU maximum value, segmentation support information, and vendor ID to destination devices.

### 8-4-1. BACnet

Sets AE-200 device number, BACnet® functions, and other settings. From [BACnet Settings], click the [BACnet] tab to display the [BACnet Settings] screen. Initial settings are as follows.

#### 8-4-1-1. AE-200/AE-50/EW-50 BACnet Settings

Sets items related to the AE-200 device number and BACnet® functions. (Items that cannot be changed are displayed in light gray.)

No.	Item	Description	Default value
1	Device No.	Set the AE-200 device number. (Setting range: 0 to 4194302)	3
2	Device Name	Set the AE-200 device name. Do not set the name that is being used for other BACnet® devices. Enter a character string of 1 to 32 alphanumeric characters and symbols. Only three types of symbols can be used (-, _, and space). A character string that consists of only space is invalid.	Device Object
3	Segmentation *1	In BACnet® communications, segmentation applies to both sending and receiving (fixed).	Both
4	APDU Segment Timeout	Set the monitoring time for segment responses to sent segmented data. (Setting range: 0 to 99999 ms) Leave [5000] as it is unless otherwise specified.	5000 (ms)
5	APDU Timeout *2	Set the monitoring time for responses to sent data. (Setting range: 0 to 99999 ms) Leave [6000] as it is unless otherwise specified.	6000 (ms)
6	APDU Retries	Set the number of send retries. (Setting range: 0 to 99) Leave [3] as it is unless otherwise specified.	3
7	I-Am Timer	Specify the AE-200 "I-Am" send period (units: seconds). (If "0", only the initial "I-Am" is sent, with no subsequent periodic sends.)	0
8	Vender ID	AE-200 vender ID appears. (MITSUBISHI ELECTRIC AC&R: 99 (fixed))	99

\*1 "Segmentation" means sending and receiving after segmenting the message when the length of the message exceeds the limit.  
"Both" indicates that segmentation applies to both sending and receiving.

\*2 "APDU Timeout" is the time interval to resend the message when the response cannot be received after the message that requires response is sent.

### 8-4-1-2. Other Settings

Sets 5 other settings items for the AE-200.

Other Settings

Use Dry Mode

Use Fan Speed Mid1/Mid2

Not reflect communication error to alarm signal

Use Operation Mode State Auto

Old Model Compatibility Mode

No.	Item	Description	Default setting
1	Use Dry Mode	Check the checkbox to use an operation mode "Dry".	Unchecked
2	Use Fan Speed Mid1/Mid2	Check the checkbox to use fan speeds Mid1 and Mid2. *1	Unchecked
3	Not reflect communication error to alarm signal	Check the checkbox <u>NOT</u> to reflect the communication error status to an alarm signal (BI_01xx03), CH_ReprAlarmSignal (BI_71tt11) and CH_UnitAlarmSignal (BI_91uu11). Leave the checkbox unchecked unless otherwise specified.	Unchecked
4	Use Operation Mode State Auto	Check the checkbox to display "Auto" whenever the operation mode is set to "Auto". Uncheck the checkbox to display the actual operation mode (Heat or Cool).	Unchecked
5	Old Model Compatibility Mode	The setting is only displayed when [Acquire settings] is performed and cannot be changed on the BACnet® Setting Tool.	Unchecked

\*1 Depending on the unit model, in addition to High/Low, this may have 2 extra fan speeds (Mid1/Mid2). Refer to the Instruction Book for air conditioning unit for details of supported equipment. Fan speeds in this case are "High" > "Mid1" > "Mid2" > "Low".

### 8-4-1-3. Use Remote BBMD

Register the AE-200 to the BBMD as an external device.

Use Remote BBMD

Time To Live  min

No.	Item	Description	Default
1	Use Remote BBMD	Check the checkbox to register the AE-200 to the BBMD as an external device.	Unchecked
2	Time To Live	Set the time limit (in minute increments) for the AE-200 to be registered to the BBMD as an external device. The setting is valid only when the checkbox is checked. (Setting range: 0 to 1092) Leave "0" as it is unless otherwise specified. ("0" means there is no time limit.)	0

## 8-4-2. Network and Device

From [BACnet Settings], click the [Network and Device] tab to display the [Network and Device Settings] screen. Assign IP addresses and port numbers to network and device numbers.

This chapter covers settings for the following devices that exchange information with the AE-200.

- Notification destination devices for COV notifications and Event notifications
- “I-Am” destination devices
- Restart notification destination devices

Connection image

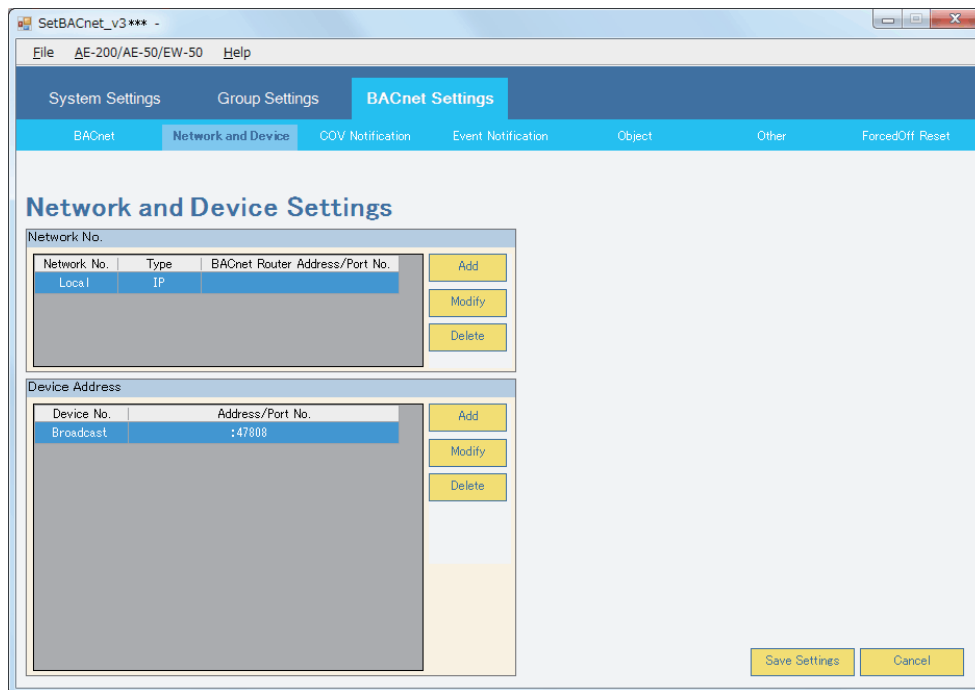
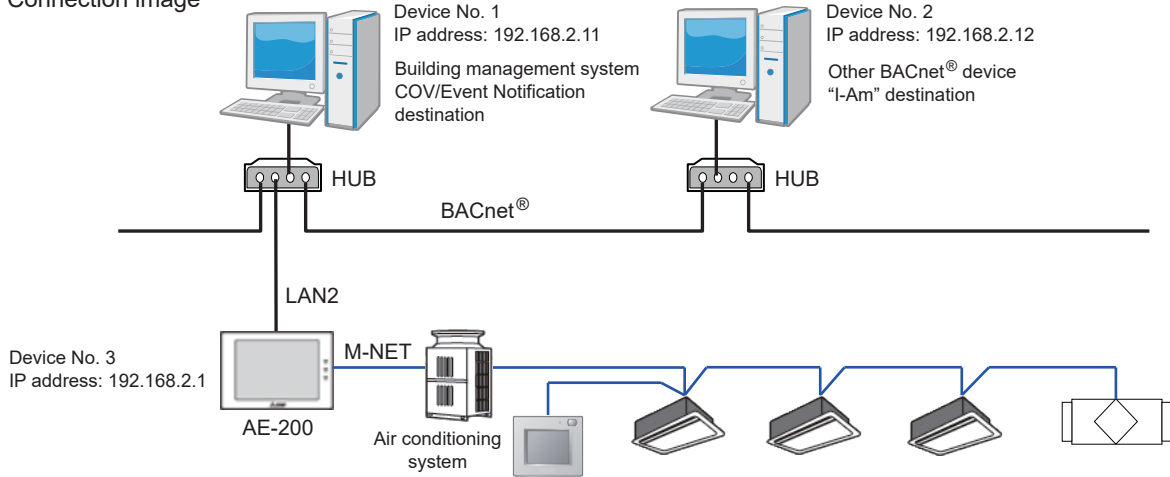

### 8-4-2-1. Network No.

Network configuration is required only when a BACnet® router is used.  
 (Only [Local] will appear in the Network No. column when no BACnet® router is used.)  
 The maximum number of network that can be configured is 5 (including Local).

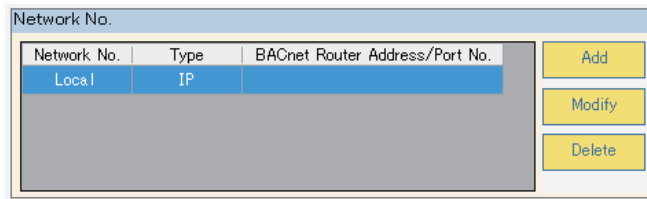

Click [Add] to display the [Network No.] popup window. Enter the network information in the fields.

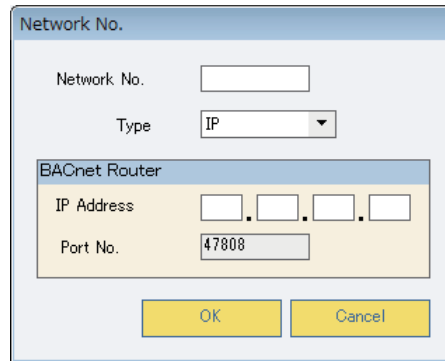

No.	Item	Description	Default
1	Network No.	Enter the network number. (Setting range: 1 to 65534) Set to "65535" when using Global Broad Cast.	(Blank)
2	Type	IP (fixed)	IP
BACnet® Router			
3	IP Address	Enter the IP address of the BACnet® router to be connected to the network that was configured in No. 1 above. (The IP address of the BACnet® router on the network to which the AE-200 is connected.)	(Blank)
4	Port No.	The number of the port that the BACnet® router uses for BACnet® communication appears here. Leave [47808] as it is unless otherwise specified.	47808



### 8-4-2-2. Device Address

Registers other devices such as central monitoring devices that send and receive data with the AE-200. A maximum of 11 devices can be registered as communications devices (including broadcast).

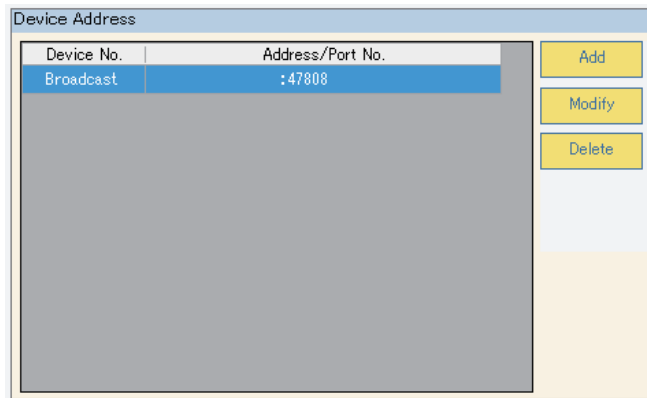

#### (1) Registering communications device

Sets communications device information. Click [Add] to display the [Device Address] pop-up window.

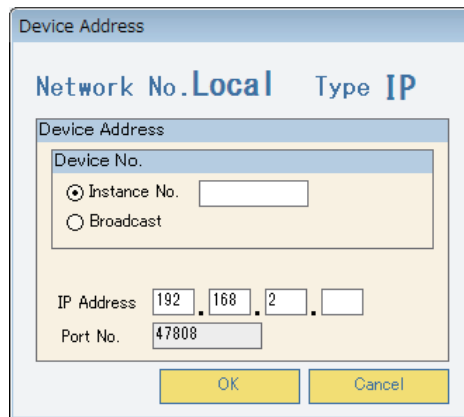

No.	Item	Description	Default
1	Instance No.	Check the radio button to set the device number. Enter the device instance number. (Setting range: 0 to 4194302)	Checked (Blank)
2	Broadcast	Check the radio button to broadcast transmission.	Unchecked
3	IP Address	Enter the IP address of the device.	192.168.2.x
4	Port No.	The BACnet® port number of the device is displayed here. Leave [47808] as it is unless otherwise specified.	47808

## (2) Changing communications device

Changes device settings. Select the device to change and click [Modify], or double-click the [Address/Port No.] to change to display the [Device Address] pop-up window.

When changing or deleting the device IP address, ensure that you check the notification destination IP address set in 8-4-3 “COV Notification” and 8-4-4 “Event Notification”. If settings are inconsistent, BACnet® connection mode may not switch to “Online”.

The screenshot shows a 'Device Address' dialog box. At the top, it says 'Device Address' in the title bar. Below that, it displays 'Network No. Local Type IP'. The main content area is titled 'Device Address' and contains a 'Device No.' section with two radio buttons: 'Instance No.' (selected) with a text box containing '1', and 'Broadcast'. Below this, there are 'IP Address' fields with values 192, 168, 2, and 101, and a 'Port No.' field with the value 47808. At the bottom, there are 'OK' and 'Cancel' buttons.

## (3) Deleting communications device

Deletes registered devices. Select the communications device to delete, and click [Delete] to delete settings. Additionally, devices with device numbers set to “Broadcast” are used as an introductory sequence, therefore cannot be deleted.

### 8-4-3. COV Notification

From [BACnet Settings], click the [COV Notification] tab to display the [COV Notification Settings] screen. This assigns device numbers registered on the [Network and Device] screen to the COV notification number. By using the COV notification number set here to set COV notifications for each control item in 8-4-5 “Object”, send COV notifications such as changes in status of control items and start-stop status in accordance with each COV notification number. Below are the initial settings.

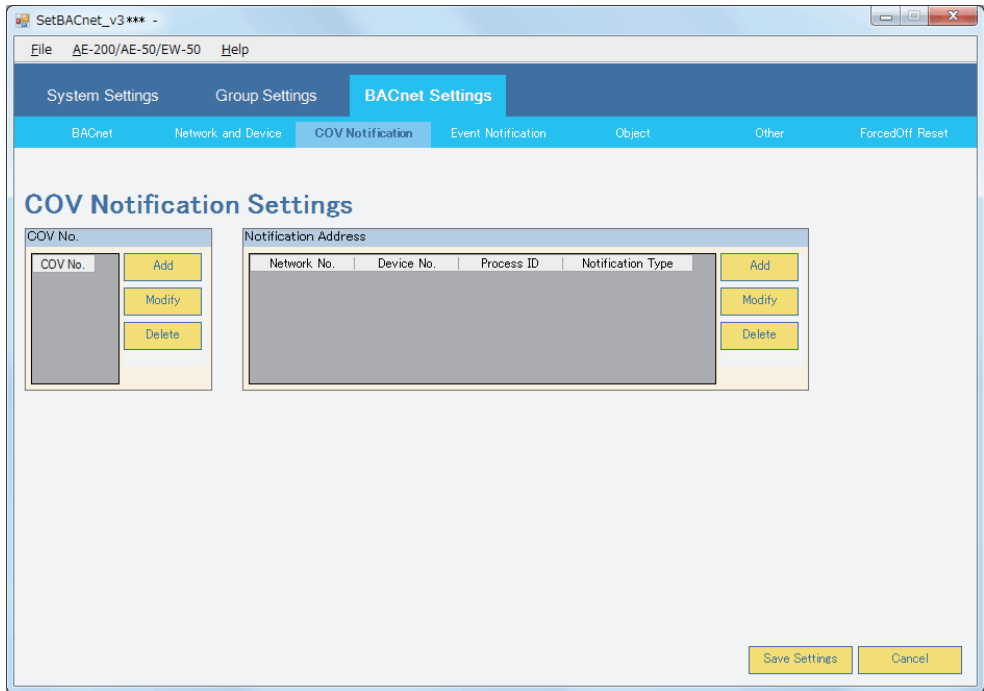

#### 8-4-3-1. COV No.

Click the [Add] or [Modify] buttons under [COV No.] to display the following window. Input the COV No., and select the [OK] button. A maximum of 5 COV numbers can be registered. Note that the range 1 to 10 can be registered as COV No.

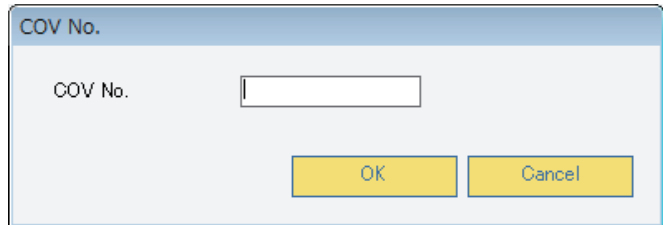

### 8-4-3-2. Notification Address

#### (1) Setting “Notification Address”

Sets the COV number notification destination device. Select the [COV No.] (left) for the device to set, and under [Notification Address] (right), click [Add] to display the [Notification Address] pop-up window. A maximum of 5 devices can be set for each COV No. (including broadcast).

No.	Item	Description	Default
Notification Address			
1	Network No.	Sets the network number for the COV notification destination device. Here, this is fixed to “Local”.	Local
2	Device No.	Sets the device number for the COV notification destination device. (Select from device numbers set in 8-4-2 “Network and Device”.)	Broadcast (When IPv4 is used)
3	Process Identifier	Sets the process ID for the COV notification destination address. (Setting range: 0 to 4294967295) Set to “0” unless otherwise specified.	0
Notification Type			
4	Unconfirmed/ Confirmed	Sets the type of the COV notification to send. Unconfirmed: Unconfirmed COV Notification Confirmed: Confirmed COV Notification	Unconfirmed

Click [Select] to display the [Network and Device Settings - Select BACnet Device] screen (figure below), from where you can select the COV notification destination device number. This screen shows the device list set in 8-4-2 “Network and Device”.

The screenshot shows a dialog box titled "Device Address" with the subtitle "Network and Device Settings – Select BACnet Device". It contains two tables and two buttons.

Network No.		
Network No.	Type	BACnet Router Address/Port No.
Local	IP	

Device Address		
Device No.	Address/Port No.	
1	192.168.2.101	:47808
2	192.168.2.102	:47808
3	192.168.2.103	:47808
4	192.168.2.104	:47808
5	192.168.2.105	:47808
6	192.168.2.106	:47808
7	192.168.2.107	:47808
8	192.168.2.108	:47808
9	192.168.2.109	:47808
10	192.168.2.110	:47808
Broadcast		:47808

Buttons: [Select] [Cancel]

In the screen above, select (reflect) the device number and click [Select] to reflect the device information selected in [Device No.] in the [Notification Address] pop-up window.

The screenshot shows a dialog box titled "Notification Address" with the subtitle "COV No. 1". It contains several input fields and buttons.

Notification Address

Network No. [Local] [Select]

Device No. [1] [Select]

Process Identifier [0]

Notification Type

Unconfirmed  Confirmed

Buttons: [OK] [Cancel]

## (2) Changing “Notification Address”

Changes the COV notification destination address settings. Select the address to change, and click [Modify] to display the [Notification Address] pop-up window. Display screens and methods for changing are the same as in (1) “Setting “Notification Address””.

## (3) Deleting “Notification Address”

Deletes the COV notification destination address settings. Select the address to delete, and click [Delete] to delete settings for the selected notification destination address.

### 8-4-4. Event Notification

From [BACnet Settings], click the [Event Notification] tab to display the [Event Notification Settings] screen. As in 8-4-3 “COV Notification”, this assigns device numbers registered on the [Network and Device] screen to the notification destination class ID. By using the notification class set here to set event notifications for each control item in 8-4-5 “Object”, send event notifications such as changes in status of control items and abnormality alarms in accordance with each notification class ID.

Below are the initial settings.

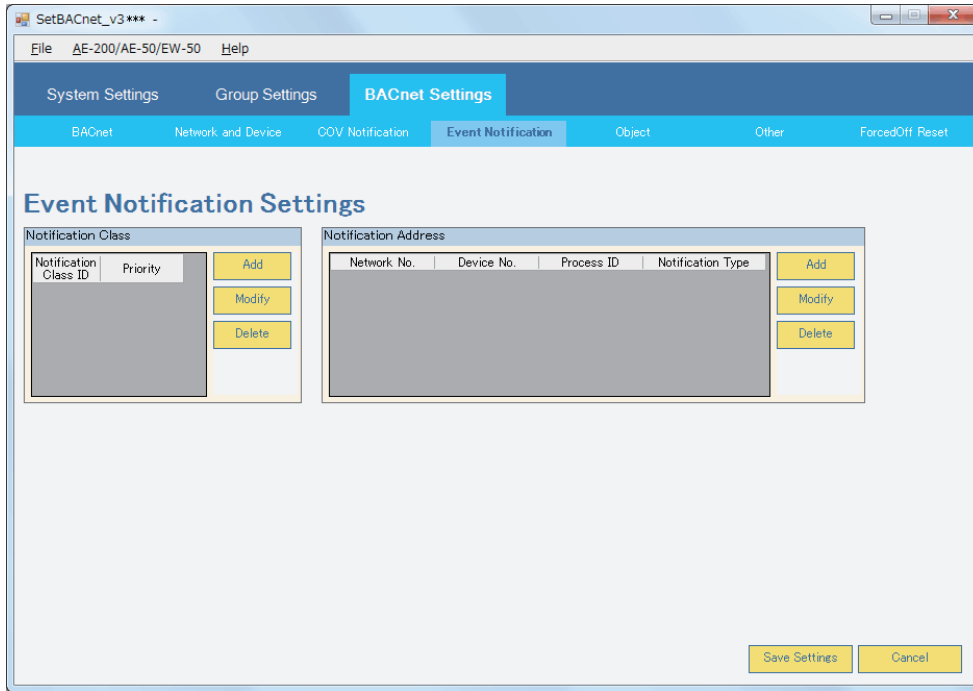

#### 8-4-4-1. Notification Class

Click the [Add] or [Modify] buttons under [Notification Class] to display the following window. Set the notification class ID and priority order for event notifications. A maximum of 5 notification class IDs can be set.

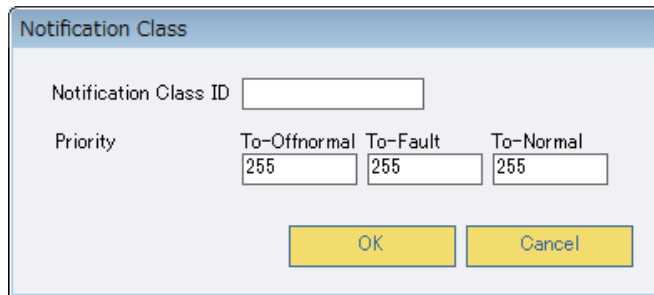

No.	Item	Description	Default value
1	Notification Class ID	Set the instance number of notification class object. (Setting range: 0 to 4194302)	(Blank)
2	Priority	Sets the priority order of event notifications for generated events (settings range: 0 to 255, lower figures indicate higher priority). Set to “255” unless otherwise specified.	255

## 8-4-4-2. Notification Address

### (1) Setting “Notification Address”

Sets the notification destination device to register in the notification class ID. Select the [Notification Class ID] for the device to set, and under [Notification Address], click [Add] to display the [Notification Address] pop-up window.

A maximum of 5 devices can be set for each notification class ID (including broadcast).

No.	Item	Description	Default
Notification Address			
1	Network No.	Sets the network number for the event notification destination device. Here, this is fixed to “Local”.	Local
2	Device No.	Sets the device number for the event notification destination device. (Select from device numbers set in 8-4-2 “Network and Device”.)	Broadcast
3	Process Identifier	Sets the process ID for the event notification destination address. (Setting range: 0 to 4294967295) Set to “0” unless otherwise specified.	0
Notification Type			
4	Unconfirmed/ Confirmed	Sets the type of the event notification to send. Unconfirmed: Unconfirmed Event Notification Confirmed: Confirmed Event Notification	Unconfirmed

Click [Select] to display the [Network and Device Settings - Select BACnet Device] screen (figure below), from where you can select the event notification destination device number. This screen shows the device list set in 8-4-2 “Network and Device”.

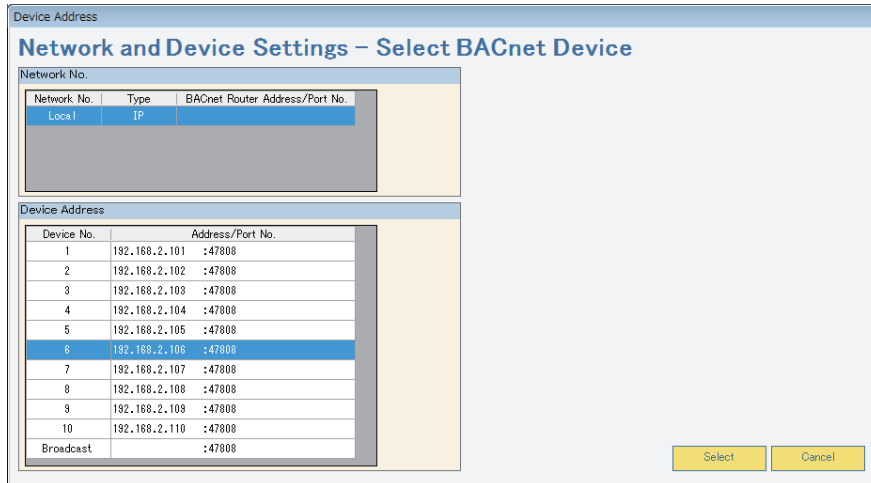

In the screen above, select (reflect) the device number and click [Select] to reflect the device information selected in [Device No.] in the [Notification Address] pop-up window.

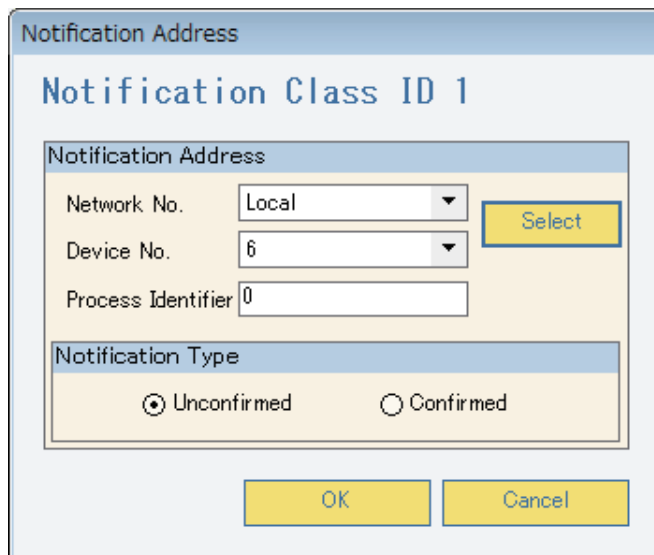

### (2) Changing “Notification Address”

Changes the event notification destination address settings. Select the address to change, and click [Modify] to display the [Notification Address] pop-up window. Display screens and methods for changing are the same as in (1) “Setting “Notification Address””.

### (3) Deleting “Notification Address”

Deletes the event notification destination address settings. Select the address to delete, and click [Delete] to delete settings for the selected notification destination address.



## 8-4-5. Object

From [BACnet Settings], click the [Object] tab to display the [Object Settings] screen. Sets objects to use with the AE-200 (control items), as well as details of COV notifications and event notifications for each object. Only those items set on this screen (Use: ) can be used as control items on the AE-200. Below are the initial settings. Leave the checkbox unchecked unless the object corresponding to the checkbox is used.

Use	Object Name	COV			Event			Type
		No.	Increment	NClassID	Offnormal	Fault	Normal	
<input checked="" type="checkbox"/>	BO_01xx01 OnOffSetup				False	False	False	
<input type="checkbox"/>	BI_01xx02 OnOffState				False	False	False	
<input type="checkbox"/>	BI_01xx03 AlarmSignal				False	False	False	
<input type="checkbox"/>	MI_01xx04 ErrorCode				False	False	False	
<input type="checkbox"/>	MO_01xx05 OperationModeSetup				False	False	False	
<input type="checkbox"/>	MI_01xx06 OperationModeState				False	False	False	
<input type="checkbox"/>	MO_01xx07 FanSpeedSetup				False	False	False	
<input type="checkbox"/>	MI_01xx08 FanSpeedState				False	False	False	
<input type="checkbox"/>	AI_01xx09 RoomTemp				False	False	False	
<input type="checkbox"/>	AV_01xx10 SetTemp				False	False	False	
<input type="checkbox"/>	BI_01xx11 FilterSign				False	False	False	
<input type="checkbox"/>	BV_01xx12 FilterSignReset				False	False	False	
<input type="checkbox"/>	BV_01xx13 ProhibitionOnOff				False	False	False	
<input type="checkbox"/>	BV_01xx14 ProhibitionMode				False	False	False	
<input type="checkbox"/>	BV_01xx15 ProhibitionFilterSignReset				False	False	False	
<input type="checkbox"/>	BV_01xx16 ProhibitionSetTemp				False	False	False	
<input type="checkbox"/>	BV_01xx17 ProhibitionFanSpeed				False	False	False	

### 8-4-5-1. Selecting objects to be used

Select objects to use with the AE-200 (control items) by selecting the check box in the [Use] field, (Use: ) / Not use: ). Check the check box to change the [Object Name] field from gray to white. Additionally, objects that are not used are displayed with [Object Name] in gray, and setting of COV notifications and event notifications is not possible. Note that setting of “DEV\_xxxxxx (Device)” and “CLS\_xxxxxx (Notification Class)” objects is not required.

Use	Object Name	COV			Event			Type
		No.	Increment	NClassID	Offnormal	Fault	Normal	
<input checked="" type="checkbox"/>	BO_01xx01 OnOffSetup				False	False	False	
<input checked="" type="checkbox"/>	BI_01xx02 OnOffState				False	False	False	
<input checked="" type="checkbox"/>	BI_01xx03 AlarmSignal				False	False	False	
<input checked="" type="checkbox"/>	MI_01xx04 ErrorCode				False	False	False	
<input checked="" type="checkbox"/>	MO_01xx05 OperationModeSetup				False	False	False	
<input checked="" type="checkbox"/>	MI_01xx06 OperationModeState				False	False	False	
<input type="checkbox"/>	MO_01xx07 FanSpeedSetup				False	False	False	
<input type="checkbox"/>	MI_01xx08 FanSpeedState				False	False	False	
<input checked="" type="checkbox"/>	AI_01xx09 RoomTemp				False	False	False	
<input checked="" type="checkbox"/>	AV_01xx10 SetTemp				False	False	False	
<input type="checkbox"/>	BI_01xx11 FilterSign				False	False	False	
<input type="checkbox"/>	BV_01xx12 FilterSignReset				False	False	False	
<input type="checkbox"/>	BV_01xx13 ProhibitionOnOff				False	False	False	
<input type="checkbox"/>	BV_01xx14 ProhibitionMode				False	False	False	
<input type="checkbox"/>	BV_01xx15 ProhibitionFilterSignReset				False	False	False	
<input type="checkbox"/>	BV_01xx16 ProhibitionSetTemp				False	False	False	
<input type="checkbox"/>	BV_01xx17 ProhibitionFanSpeed				False	False	False	

**(1) Objects used for temperature setting commands from the central monitoring device**

Temperature setting objects that can be used differ depending on indoor unit group configuration. When setting temperature from the central monitoring device, use temperature setting objects that match the indoor unit group configuration.

Groups for which “Old Model Compatibility Mode” is off, and groups within which all indoor units support “Dual-set-point mode in the Auto mode” are groups that support “Dual-set-point mode in the Auto mode”.

Groups for which “Old Model Compatibility Mode” is on, or groups within which there are indoor units that do not support “Dual-set-point mode in the Auto mode” are groups that do NOT support “Dual-set-point mode in the Auto mode”.

For groups supporting dual-set-point mode, issue commands using dual-set-point mode objects (AV\_ xxxx24 to AV\_ xxxx28); and for groups not supporting dual-set-point mode, issue commands using indoor temperature set value objects (AV\_ xxxx10).

If the central monitoring device issues a command for groups that do not support dual-set-point mode using a dual-set-point mode object, then the AE-200 will return an error to the central monitoring device.

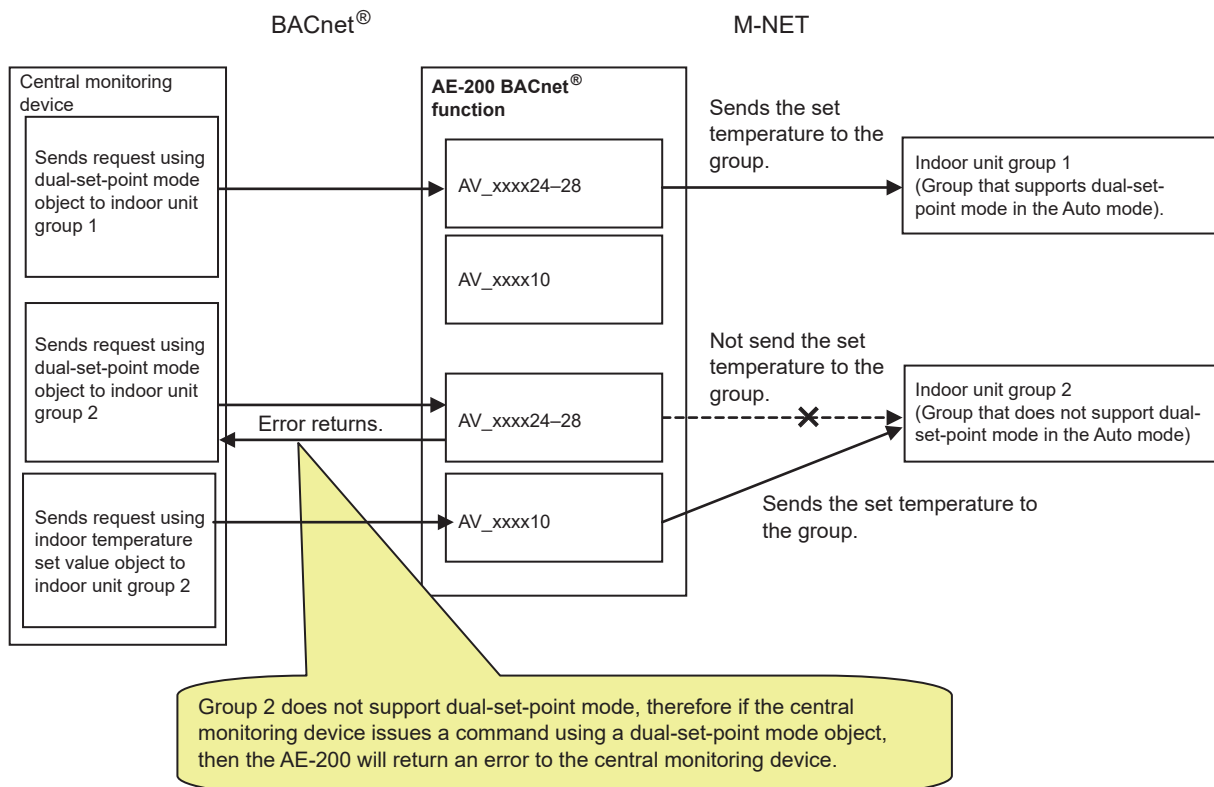

Select the temperature setting objects according to the indoor unit group configuration in a given air conditioning system.

V: Available  
—: Not available

	Indoor unit group configuration in the air conditioning system		
	Groups that do not support the dual-set-point mode in the Auto mode	Groups that support the dual-set-point mode in the Auto mode	
		Dual-set-point mode *1	Single-set-point mode *1
AV_ xxxx10 Set Temp	V	—	—
AV_ xxxx24 Set TempCool	—	V	V
AV_ xxxx25 Set TempHeat	—	—	V
AV_ xxxx26 Set TempAuto	—	—	V
AV_ xxxx27 Set High Limit SetbackTemp	—	V *2	V *2
AV_ xxxx28 Set Low Limit SetbackTemp	—		

\*1 The mode can be switched from a remote controller. The mode cannot be switched on the AE-200’s LCD. (The mode can not be switched on some models of indoor unit.)

\*2 These objects can be selected when the indoor unit group supports the Setback function.

## (2) Objects used for apportioned electricity billing function

Uses the apportioned electricity billing function to store electric energy apportioned by group or interlocked unit in an accumulator object. Reads current accumulator object values for each collection cycle, and stores this in the trend log object.

When using the apportioned electricity billing function, a “Charge” license is required for each AE-200, and the settings for the apportioned electricity billing function using the AE-200 Initial Setting Tool is required. Information that can be read from BACnet® is electric energy or apportionment parameters, and this does not calculate charges.

Accumulator objects and trend log objects are as follows.

Object name	Description
<Accumulator object>	
AC_01xx39	Group Apportioned Electric Energy *1 Stores cumulative value of electric energy for each group.
AC_61aa39	Interlocked Units Apportioned Electric Energy *2*6 Stores cumulative value of electric energy for each interlocked unit.
AC_41mm40–43	PI controller Electric Energy 1–4 *3 Stores cumulative value (4 channels) of electric energy accumulated with the PI controller.
AC_410040–43	Pulse Input Electric Energy 1–4 *3 Stores cumulative value (4 channels) of electric energy accumulated with the AE-50/EW-50 built-in Pulse Input (PI). *5
AC_01xx44	Group Apportionment Parameter *1 Stores cumulative value of electric energy apportionment parameter for each group.
AC_61aa44	Interlocked Units Apportionment Parameter *2*6 Stores cumulative value of electric energy apportionment parameter for each interlocked unit.
<Trend Log object> *4	
LOG_01xx83	Trend Log Group Apportioned Electric Energy Accumulates the accumulator (AC_01xx39) “Present_Value” for each collection cycle (Log_Interval property).
LOG_61aa83	Trend Log Interlocked Units Apportioned Electric Energy Accumulates the accumulator (AC_61aa39) “Present_Value” for each collection cycle (Log_Interval property).
LOG_41mm84–87	Trend Log PI controller Electric Energy 1–4 Accumulates the accumulator (AC_41mm40–43) “Present_Value” for each collection cycle (Log_Interval property).
LOG_410084–87	Trend Log Pulse Input Electric Energy 1–4 Accumulates the accumulator (AC_410040–43) “Present_Value” for each collection cycle (Log_Interval property).
LOG_01xx88	Trend Log Group Apportionment parameter Accumulates the accumulator (AC_01xx44) “Present_Value” for each collection cycle (Log_Interval property).
LOG_61aa88	Trend Log Interlocked Units Apportionment Parameter Accumulates the accumulator (AC_61aa44) “Present_Value” for each collection cycle (Log_Interval property).

\* xx: Group number (01–50)

\* mm: PI controller address (01–50), Pulse Input (00)

\* aa: Interlocked unit address (01–50)

\*1 “Group Apportioned Electric Energy” and “Group Apportionment Parameter” cannot be used at the same time. If you try to check the check boxes of both objects, then one of the check boxes will be automatically deselected.

\*2 “Interlocked Units Apportioned Electric Energy” and “Interlocked Units Apportionment Parameter” cannot be used at the same time. If both are selected, then one of the check boxes will be automatically deselected.

\*3 “Pulse Input Electric Energy” settings are common to “PI controller Electric Energy”. When using “Pulse Input Electric Energy 1–4”, select the check box of the “PI controller Electric Energy 1–4” object.

\*4 If selecting the Trend Log object check box, the collection target accumulator object check box will also be automatically selected.

\*5 When using an apportioned electricity billing function, a built-in Pulse Input (PI) of AE-200 cannot be used.

\*6 Objects for the OA Processing units that are interlocked with indoor units

### 8-4-5-2. Notification Setting

Select the [Use] check box (  ), and set notifications (COV Notification and Event Notification) for enabled control items (objects).

#### (1) Setting COV Notification and Event notification

Double-click the control items (objects) to set, and the [Notification Setting] pop-up window as below will be displayed. Display of pop-up windows for objects that have not been selected using check boxes in the [Use] field is not possible. Depending on object names, setting of event notifications and “COV Increment” may not be possible. (See table “Support for COV notifications and event notifications”)

As shown below, initial status for both COV notification and event notification is disabled (Example: BI\_01xx20 communications status).

No.	Item	Description	Default
<b>Use COV</b>			
1	Use COV	Check the checkbox to use COV notification.	Unchecked
2	COV No.	Set the COV No. (destination). *1	1
3	COV Increment	Set the “value change increment” for COV notifications responding to value changes. Only settings for temperature measurement value and temperature settings value notifications are possible. (Setting range: 0.000001 to 99.99999) Leave “1.0” as it is unless otherwise specified. (For systems that support room temperature setting in 0.5°C increments, setting to “0.5” is recommended.)*2	1.0
<b>Use Event</b>			
4	Use Event	Check the checkbox to use Event Notification. When the checkbox is checked, the No. 6, 7, and 8 items are checked as well.	Unchecked
5	Notification Class ID	Set the Notification Class (destination). *3	1
<b>Event-Enable</b>			
6	To-Offnormal	Check the checkbox for event notifications resulting from Normal or Fault → Offnormal.	Checked
7	To-Fault	Check the checkbox for event notifications resulting from Normal or Offnormal → Fault.	Checked
8	To-Normal	Check the checkbox for event notifications resulting from Offnormal or Fault → Normal.*4	Checked
<b>Notify Type</b>			
9	Alarm	Check the checkbox when the Event Notification Type is “Alarm”.	Checked
10	Event	Check the checkbox when the Event Notification Type is “Event”.	Unchecked

- \*1 Select the "COV No." from the [COV Notification Settings - Select COV No.] pop-up window below, displayed by clicking [Select]. This screen shows the COV number list registered in 8-4-3 "COV Notification".

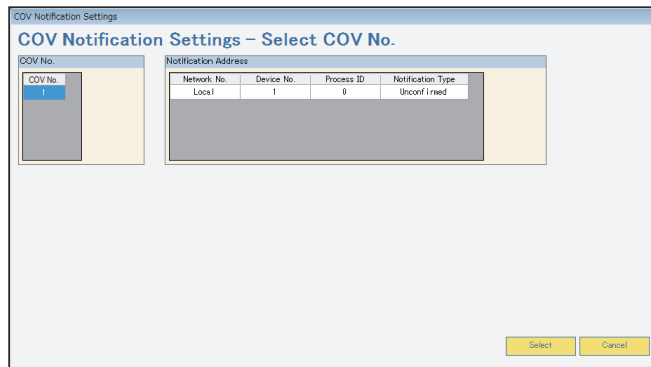

- \*2 COV notification is sent when there is a change by the increase/decrease portion set by the COV Increment. However, because the indication on the AE-200's LCD and the Web display are rounded off using Swedish rounding, a difference from the notified value may occur.
- \*3 Select the [Notification Class] from the [Event Notification Settings - Select Notification Class ID] pop-up window below, displayed by clicking [Select]. This screen shows the notification class ID list set in 8-4-4 "Event Notification".

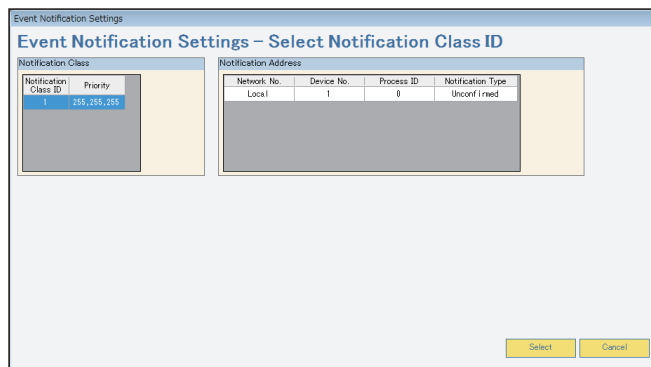

- \*4 If [To-Offnormal] or [To-Fault] is checked, ensure to check [To-Normal].

Whether or not COV notification and event notification settings are possible for objects is shown below.

Support for COV notifications and event notifications (V: Settable/—: Not settable)

Control item	Object ID	COV Notification	COV Increment	Event Notification
OnOffSetup	BO_01xx01	V	—	V
OnOffState	BI_01xx02	V	—	V
AlarmSignal	BI_01xx03	V	—	V
ErrorCode	MI_01xx04	V	—	—
OperationalModeSetup	MO_01xx05	V	—	—
OperationalModeState	MI_01xx06	V	—	—
FanSpeedSetup	MO_01xx07	V	—	—
FanSpeedState	MI_01xx08	V	—	—
RoomTemp [WaterTemp]	AI_01xx09	V	V	V
SetTemp [SetWaterTemp]	AV_01xx10	V	V	—
FilterSign [CirculatingWaterExchangeSign]	BI_01xx11	V	—	V
FilterSignReset [CirculatingWaterExchangeSign Reset]	BV_01xx12	V	—	—
ProhibitionOnOff	BV_01xx13	V	—	—
ProhibitionMode	BV_01xx14	V	—	—
ProhibitionFilterSignReset [ProhibitionCirculatingWater ExchangeSignReset]	BV_01xx15	V	—	—
ProhibitionSetTemperature	BV_01xx16	V	—	—
ProhibitionFanSpeed	BV_01xx17	V	—	—
M-NETCommunicationState	BI_01xx20	V	—	V
SystemForcedOff *1	individual	BV_01xx21	V	—
	collective	BV_019921	V	—
AirDirectionSetup	MO_01xx22	V	—	—
AirDirectionState	MI_01xx23	V	—	—
SetTempCool	AV_01xx24	V	V	—
SetTempHeat	AV_01xx25	V	V	—
SetTempAuto	AV_01xx26	V	V	—
SetHighLimitSetbackTemp	AV_01xx27	V	V	—
SetLowLimitSetbackTemp	AV_01xx28	V	V	—
VentilationModeSetup	MO_01xx35	V	—	—
VentilationModeState	MI_01xx36	V	—	—
AirToWaterModeSetup	MO_01xx37	V	—	—
AirToWaterModeState	MI_01xx38	V	—	—
GroupApportionedElectricEnergy	AC_01xx39	—	—	V
InterlockedUnitsApportionedElectric Energy	AC_61aa39	—	—	V
PlcontrollerElectricEnergy 1–4	AC_41mm40–43	—	—	V
PulseInputElectricEnergy 1–4	AC_410040–43	—	—	V
GroupApportionmentParameter	AC_01xx44	—	—	V
InterlockedUnitsApportionment Parameter	AC_61aa44	—	—	V
NightPurgeState	BI_01xx46	V	—	V
ThermoOnOffState	BI_01xx47	V	—	V
SystemAlarmSignal	BI_010048	V	—	V
ErrorCodeDetail	AI_01xx49	V	—	—

Control item	Object ID	COV Notification	COV Increment	Event Notification
ExternalHeatSourceState	BI_01xx50	V	—	V
PIcontrollerAlarmSignal	BI_41mm03	V	—	V
TrendLogRoomTemp	LOG_01xx80	—	—	—
TrendLogGroupApportionedElectricEnergy	LOG_01xx83	—	—	—
TrendLogInterlockedUnitsApportionedElectricEnergy	LOG_61aa83	—	—	—
TrendLogPIcontrollerElectricEnergy 1-4	LOG_41mm84-87	—	—	—
TrendLogPulseInputElectricEnergy 1-4	LOG_410084-87	—	—	—
TrendLogGroupApportionmentParameter	LOG_01xx88	—	—	—
TrendLogInterlockedUnitsApportionmentParameter	LOG_61aa88	—	—	—
Device	DEV_xxxxxx	—	—	—
NotificationClass	CLS_xxxxxx	—	—	—
CH_OnOffSetup	BO_71tt01	V	—	V
CH_OnOffState	BI_71tt02	V	—	V
CH_OperationModeSetup	MO_71tt03	V	—	—
CH_OperationModeState	MI_71tt04	V	—	—
CH_FanModeSetup	MO_71tt05	V	—	—
CH_FanModeState	MI_71tt06	V	—	—
CH_SetTempCool	AV_71tt07	V	V	—
CH_SetTempHeat	AV_71tt08	V	V	—
CH_ReprInletWaterTemp	AI_71tt09	V	—	V
CH_ReprOutletWaterTemp	AI_71tt10	V	—	V
CH_ReprAlarmSignal	BI_71tt11	V	—	V
CH_CommunicationState	BI_71tt12	V	—	V
CH_ProhibitionOnOff	BV_71tt15	V	—	—
CH_ProhibitionMode	BV_71tt16	V	—	—
CH_ProhibitionSetTemp	BV_71tt17	V	—	—
CH_UnitAlarmSignal	BI_91uu11	V	—	V

\* xx: Group number (01-50)

mm: PI controller address (01-50), Pulse Input (00)

aa: Interlocked unit address (01-50)

tt: Group number of simultaneously operated units including a system representative unit (01-50)

uu: Unit address (01-50)

\*1 To use either "individual" or "collective," select the check box in the [Use] field for BV\_01xx21.

### 8-4-6. Others

From [BACnet Settings], click the [Object] tab to display the [Other Settings] screen. This screen displays “Restart Notification Recipients” settings.

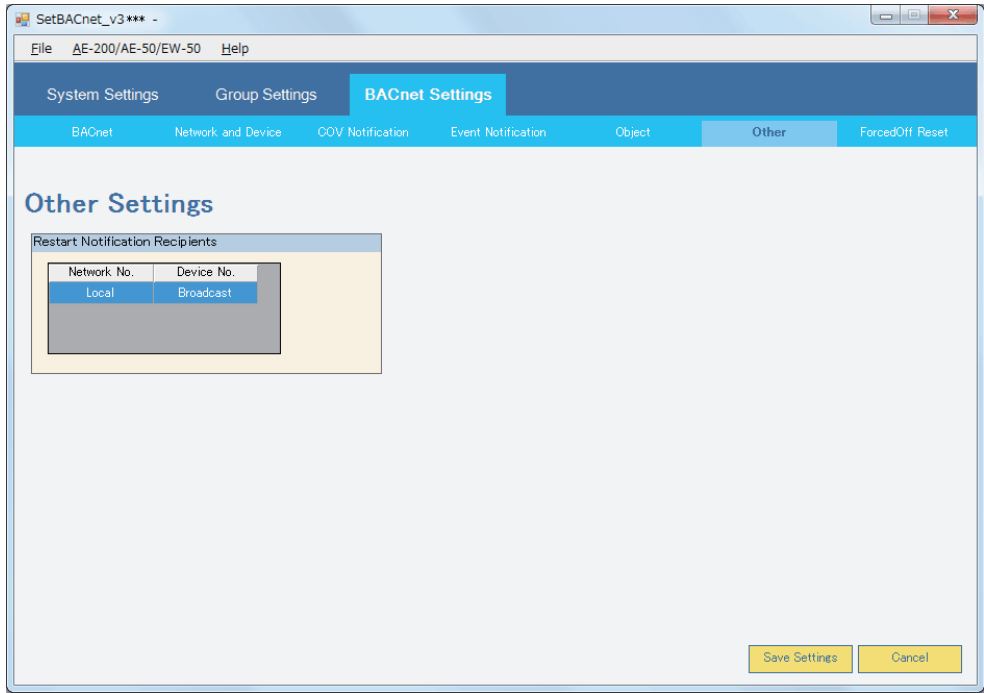

#### [1] Restart Notification Recipients

Displays introduction sequence at AE-200 start-up, and “I-Am” periodic transmission destination device settings.

Default value settings are as follows. Additionally, settings values for these items cannot be changed.

No.	Item	Default setting
Restart Notification Recipients		
1	Network No.	Local
2	Device No.	Broadcast (192.168.2.255)



### 8-4-7. ForcedOff Reset

From [BACnet Settings], click the [ForcedOff Reset] tab to display the [ForcedOff Reset] screen. During an AE-200 emergency stop, clicking the [ForcedOff Reset] button from the central monitoring device (BACnet®) will cancel the AE-200 emergency stop.

**This function is used when canceling an AE-200 emergency stop from the central monitoring device (BACnet®) is not possible due to trouble with the central monitoring device (BACnet®). When using this function to cancel an AE-200 emergency stop, before executing this operation, first confirm with the building manager that there is no problem with canceling the emergency stop.**

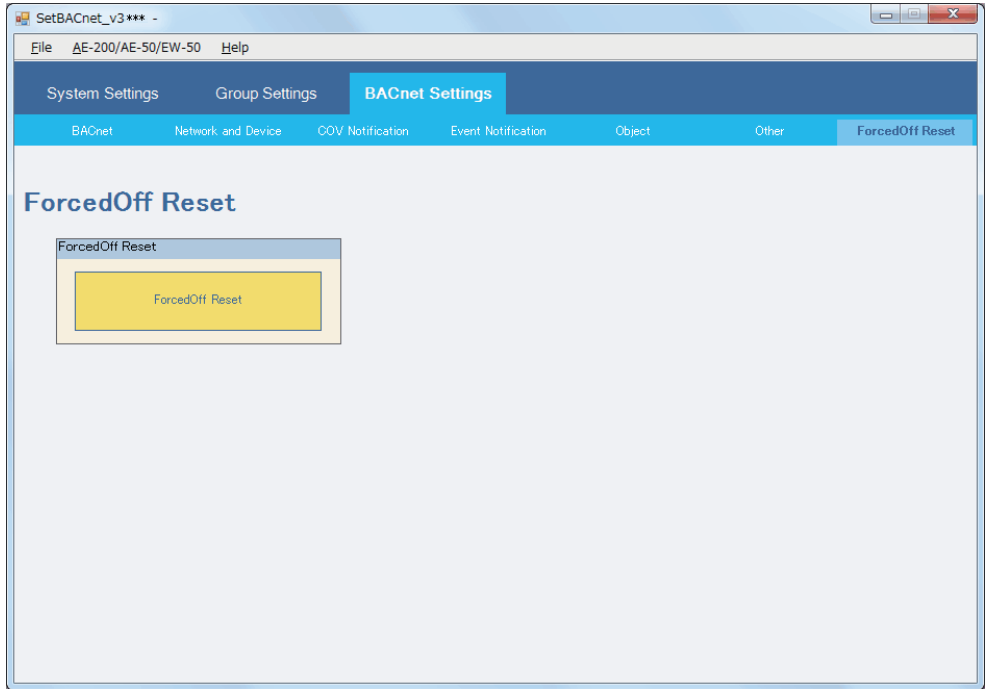

#### [1] ForcedOff Reset

No.	Item	Description
1	ForcedOff Reset button	Click to send the "ForcedOff Reset" command to AE-200.

## Attachment 1 BACnet® network configuration and settings examples

The AE-200 only supports BACnet®/IP.

The following are types of BACnet® network configuration.

	Network configuration	Description
(1)	Local network	Local network configuration, without going through a router
(2)	BACnet® router connection	Configuration in which each network connects through a BACnet® router
(3)	IP router connection	Configuration in which each network connects through an IP router
(4)	IP router + BBMD connection	Configuration in which each network connects through an IP router (with broadcast message transfer BBMD)
(5)	IP router + Remote BBMD connection	Configuration in which each network connects through an IP router (with broadcast message transfer remote BBMD)

### (1) Local network

#### 1. Sample local network configuration

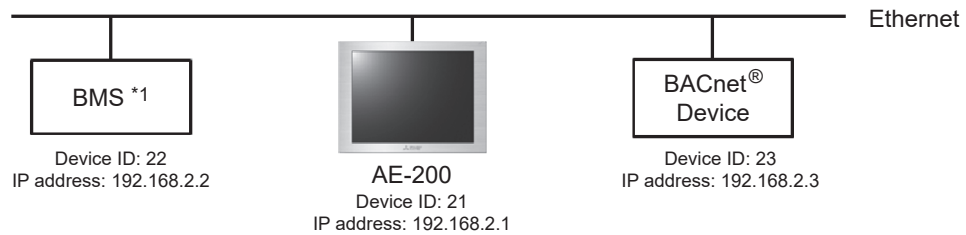

\*1 BMS: Building Management System

#### 2. Configuring the Network and Device Settings

The [Network and Device Settings] screen below shows the settings for the sample local network configuration above.

### Network and Device Settings

Network No.

Network No.	Type	BACnet Router Address/Port No.	
Local	IP		Add
			Modify
			Delete

Device Address

Device No.	Address/Port No.	
22	192.168.2.2 :47808	Add
23	192.168.2.3 :47808	Modify
Broadcast	:47808	Delete

## (2) BACnet® router connection

Multiple networks can be connected via BACnet® routers.

### 1. Sample network configuration with the use of BACnet® routers

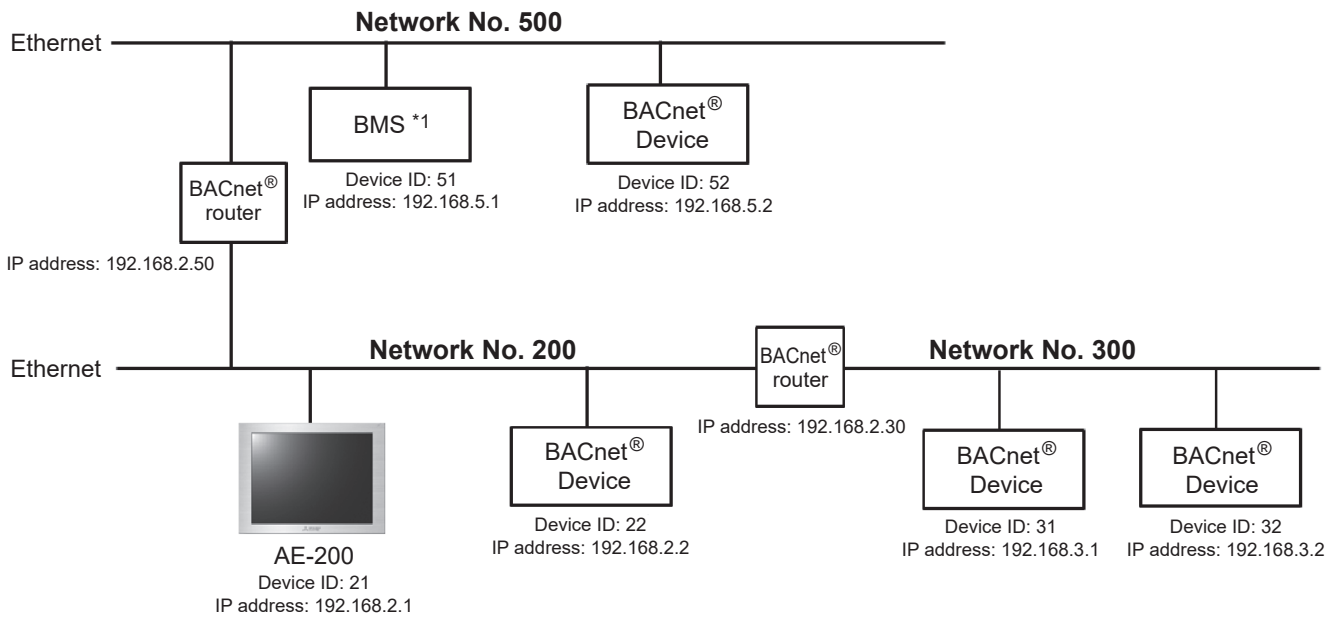

\*1 BMS: Building Management System

### 2. Configuring the Network and Device Settings

The [Network and Device Settings] screen below shows the settings for the sample network configuration with the use of BACnet® routers above.

<Local (Network No.200) settings>

Network and Device Settings			
Network No.			
Network No.	Type	BACnet Router Address/Port No.	<input type="button" value="Add"/> <input type="button" value="Modify"/> <input type="button" value="Delete"/>
Local	IP		
300	IP	192.168.2.30 :47808	
500	IP	192.168.2.50 :47808	
Global	IP		
Device Address			
Device No.	Address/Port No.		<input type="button" value="Add"/> <input type="button" value="Modify"/> <input type="button" value="Delete"/>
22	192.168.2.2 :47808		
Broadcast	:47808		

<Network No.300 settings>

Network and Device Settings			
Network No.			
Network No.	Type	BACnet Router Address/Port No.	<input type="button" value="Add"/> <input type="button" value="Modify"/> <input type="button" value="Delete"/>
Local	IP		
300	IP	192.168.2.30 :47808	
500	IP	192.168.2.50 :47808	
Global	IP		
Device Address			
Device No.	Address/Port No.		<input type="button" value="Add"/> <input type="button" value="Modify"/> <input type="button" value="Delete"/>
31	192.168.3.1 :47808		
32	192.168.3.2 :47808		
Broadcast	:		

<Network No.500 settings>

### Network and Device Settings

Network No.

Network No.	Type	BACnet Router Address/Port No.
Local	IP	
300	IP	192.168.2.30 :47808
500	IP	192.168.2.50 :47808
Global	IP	

Device Address

Device No.	Address/Port No.
51	192.168.5.1 :47808
52	192.168.5.2 :47808
Broadcast	:

<Global Broadcast settings>

### Network and Device Settings

Network No.

Network No.	Type	BACnet Router Address/Port No.
Local	IP	
300	IP	192.168.2.30 :47808
500	IP	192.168.2.50 :47808
Global	IP	

Device Address

Device No.	Address/Port No.
Broadcast	:47808

### (3) IP router connection

Networks connect through an IP router.

#### 1. Sample network configuration with the use of IP routers

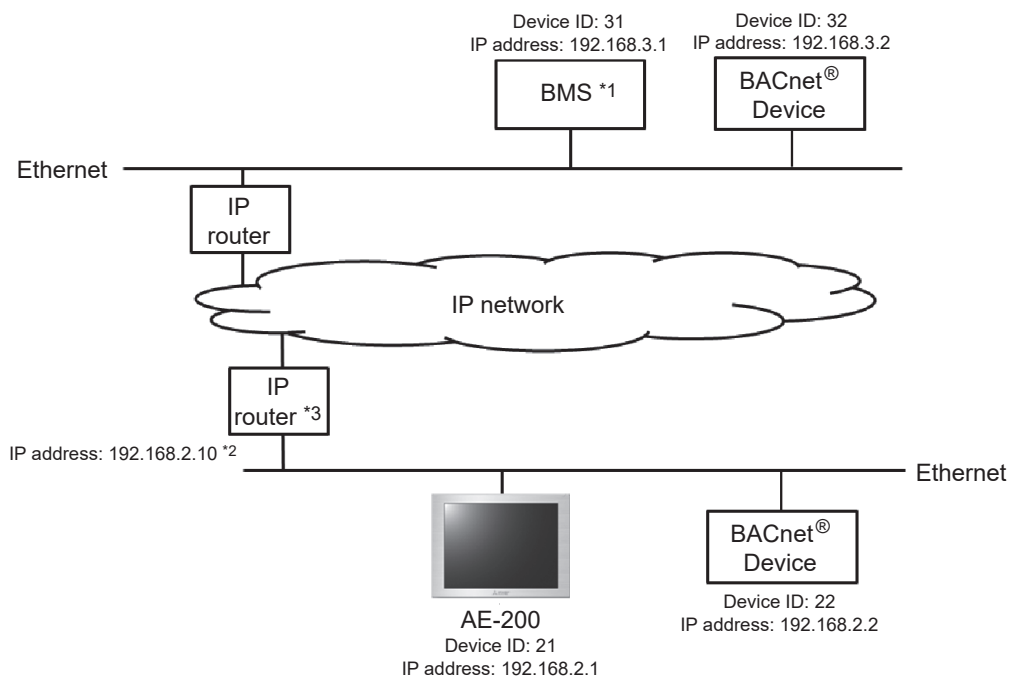

\*1 BMS: Building Management System

\*2 IP address of IP router for network to which AE-200 is connected

\*3 The IP router forwards unicast messages across networks, but not broadcast messages. If using broadcast messages, ensure design in order that these do not leave IP routers.

## 2. Configuring the Network and Device Settings

The [Network and Device Settings] screen below shows the settings for the sample network configuration with the use of IP routers above. "Network No." is "Local".

Network No.		
Network No.	Type	BACnet Router Address/Port No.
Local	IP	

Device Address	
Device No.	Address/Port No.
22	192.168.2.2 :47808
31	192.168.3.1 :47808
32	192.168.3.2 :47808
Broadcast	:47808

The use of IP routers will require the default gateway setting to be configured beforehand. (Refer to 8-2-1-2 "LAN2 (for BACnet®)" for details.)

System Settings | Group Settings | BACnet Set

Basic System

### Basic System

LAN1 (for air conditioning system)

IP Address: 192 . 168 . 1 . 1  
Subnet Mask: 255 . 255 . 255 . 0  
MAC Address:

LAN2 (for BACnet)

IP Address: 192 . 168 . 2 . 1  
Subnet Mask: 255 . 255 . 255 . 0  
Default Gateway: 192 . 168 . 2 . 10  
MAC Address:  
BACnet Port No.: 47808

#### (4) IP router + BBMD connection

Multiple networks can be connected via IP routers. Broadcast messages across networks are transferred by BBMDs.

##### 1. Sample network configuration with the use of IP routers and BBMDs

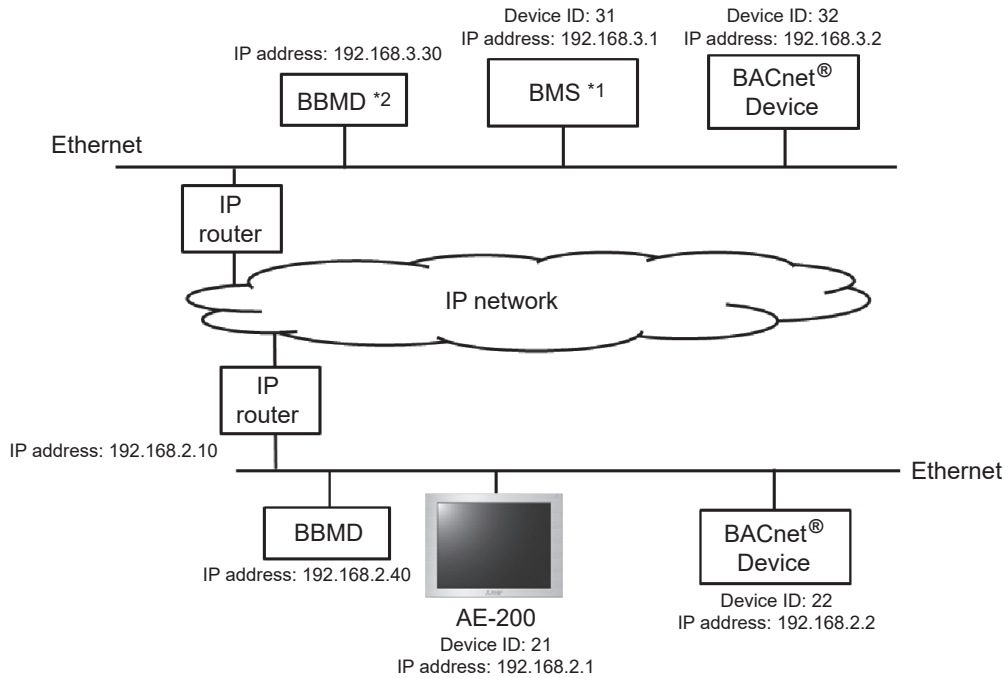

\*1 BMS: Building Management System

\*2 BBMD: BACnet®/IP Broadcast Management Device

##### 2. Configuring the Network and Device Settings

The [Network and Device Settings] screen below shows the settings for the sample network configuration with the use of IP routers above.

“Network No.” is “Local”. Set the Device No. and Address.

**Network and Device Settings**

Network No.

Network No.	Type	BACnet Router Address/Port No.
Local	IP	

Add  
Modify  
Delete

Device Address

Device No.	Address/Port No.
22	192.168.2.2 :47808
31	192.168.3.1 :47808
32	192.168.3.2 :47808
Broadcast	:47808

Add  
Modify  
Delete

The use of IP routers will require the default gateway setting to be configured beforehand.  
(Refer to 8-2-1-2 “LAN2 (for BACnet®)” for details.)

The screenshot shows the 'SetBACnet\_v3\*\*\*' configuration window. The 'Basic System' tab is selected. Under the 'Basic System' section, there are two LAN configuration areas. The 'LAN2 (for BACnet)' section is highlighted with a red box around its 'Default Gateway' field, which is set to 192.168.2.10. The 'LAN1 (for air conditioning system)' section has an IP Address of 192.168.1.1 and a Subnet Mask of 255.255.255.0. The 'LAN2 (for BACnet)' section has an IP Address of 192.168.2.1, a Subnet Mask of 255.255.255.0, and a BACnet Port No. of 47808.

When using remote BBMD, configure the “Use Remote BBMD” setting beforehand.  
(Refer to 8-4-1-3 “Use Remote BBMD” for details.)

### 3. Message transmission across networks

IP routers transfer unicast messages across networks, but not broadcast messages.  
BBMDs are used to transmit broadcast messages across networks.

BBMD (transmission originator) transforms broadcast messages into BBMD transfer messages, and these messages are sent to the transmission destination BBMD through IP routers.

(Originator BBMD -> IP router -> IP network -> IP router -> Destination BBMD)

The transmission destination BBMD transforms the received BBMD transfer messages into broadcast messages and transmit them to the devices on the target network.

AE-200 sends broadcast messages to the following devices:

- All devices that belong to the same network as the AE-200
- All devices connected to other networks via the BBMDs

#### Important

Transferring messages between BBMDs will require the BDT (Broadcast Distribution Table) settings on the BBMDs to be made. It is assumed here that the BDT settings have already been made.

**(5) IP router + Remote BBMD connection (without a connection of BBMD to the local network)**

Networks can also be connected via IP routers. Broadcast messages are transmitted across networks via remote BBMDs that are connected to other networks.

1. Sample network configuration with the use of IP routers and BBMDs

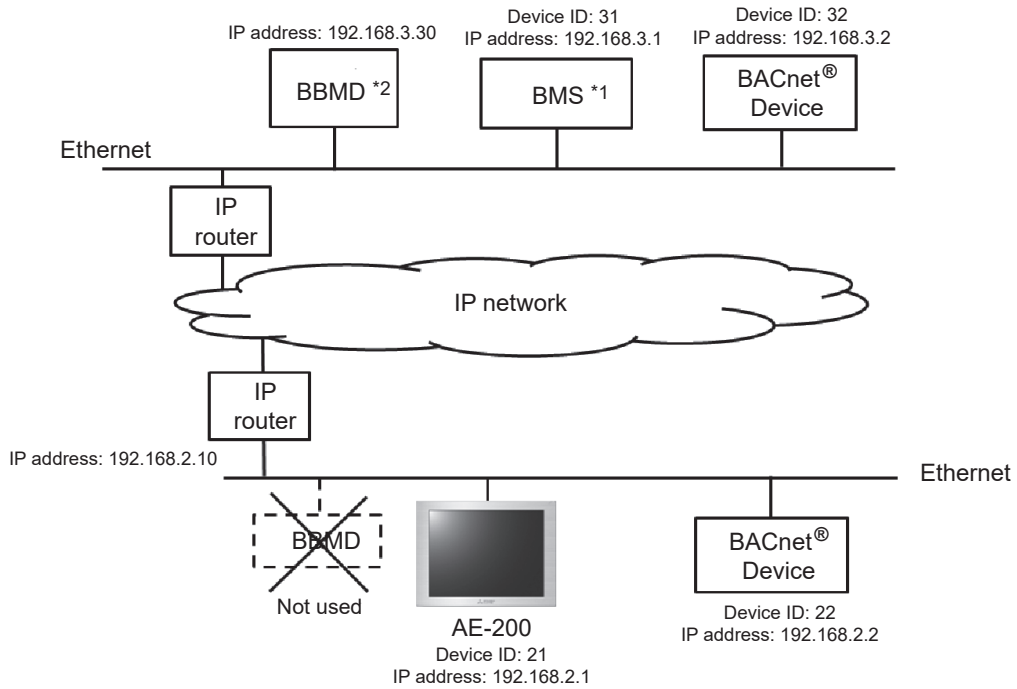

\*1 BMS: Building Management System

\*2 Remote BBMD: Remote BACnet®/IP Broadcast Management Device

2. Configuring the Network and Device Settings

The [Network and Device Settings] screen below shows the settings for the sample network configuration with the use of IP routers above.

“Network No.” is “Local”. Set the Device No. and Address.

**Network and Device Settings**

Network No.

Network No.	Type	BACnet Router Address/Port No.
Local	IP	

Add  
Modify  
Delete

Device Address

Device No.	Address/Port No.
22	192.168.2.2 :47808
31	192.168.3.1 :47808
32	192.168.3.2 :47808
Broadcast	:47808

Add  
Modify  
Delete



The use of IP routers will require the default gateway setting to be configured beforehand. (Refer to 8-2-1-2 “LAN2 (for BACnet®)” for details.)

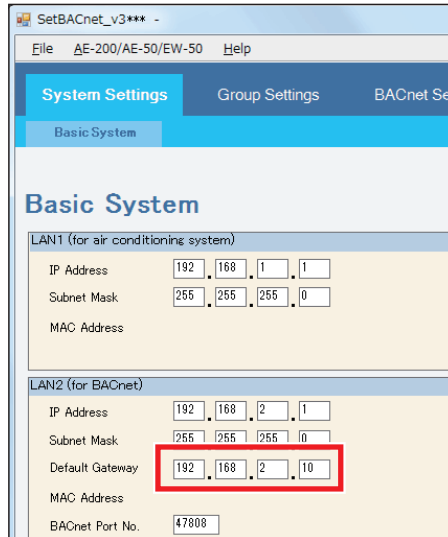

The use of remote BBMD will require the “Use Remote BBMD” setting to be configured beforehand. (Refer to 8-4-1-3 “Use Remote BBMD” for details.)

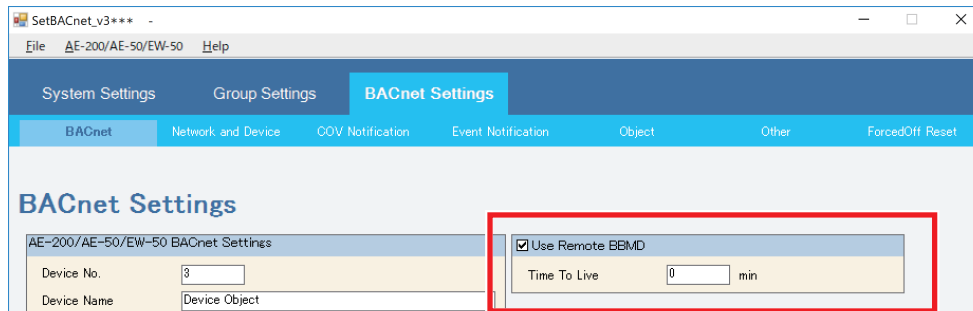

### 3. Message transmission across networks

IP routers transfer Unicast messages across networks, but not broadcast messages. BBMDs are used to transmit broadcast messages across networks.

If no BBMD is connected to the transmission originator device network, use a remote BBMD (one that is connected to another network).

To use a remote BBMD, register the information of the device to be connected to the remote BBMD as an external device. The IP address of the remote BBMD to be connected will be required.

A transmission originator device sends a transfer request message to a remote BBMD. The remote BBMD that received the transfer message will transform the message to a BBMD transfer message, and sends it to the destination BBMD via IP routers.

(Originator Remote BBMD → IP router → IP network → IP router → Destination BBMD).

The transmission destination BBMD transforms the received BBMD transfer messages into broadcast messages and transmit them to the devices on the target network.

Broadcast messages from other networks are transferred by the remote BBMD to an external device.

#### Important

Transferring messages between BBMDs will require the BDT (Broadcast Distribution Table) settings on the BBMDs to be made. It is assumed here that the BDT settings have already been made.

## Appendix: Added functions

The table below summarizes the newly added functions.

Version	Added item	Description	Reference
Ver. 7.98	Windows® 11 compatible	A computer with Windows® 11 is compatible for use.	Section 1-3 "PC requirements"
	.NET Framework 4.8 compatible	Supports the use of .NET Framework 4.8	Section 1-3 "PC requirements"



---

This product is designed and intended for use in the residential,  
commercial and light-industrial environment.

The product at hand is based on the following EU regulations:

- Low Voltage Directive 2014/35/EU
- Electromagnetic Compatibility Directive 2014/30/EU

Please be sure to put the contact address/telephone number  
on this manual before handing it to the customer.

## **MITSUBISHI ELECTRIC CORPORATION**

HEAD OFFICE: TOKYO BLDG., 2-7-3, MARUNOUCHI, CHIYODA-KU, TOKYO 100-8310, JAPAN  
MANUFACTURER: MITSUBISHI ELECTRIC CORPORATION Air-conditioning & Refrigeration Systems Works  
5-66, Tebira 6 Chome, Wakayama-city, 640-8686, Japan

WT07921X06