

PLA-A42EA7 & PUZ-A42NKA7(-BS)
42,000 BTU/H 3' X 3' CEILING CASSETTE
42,000 BTU/H HEAT PUMP UNIVERSAL OUTDOOR



Job Name:

System Reference:

Date:



Indoor Unit.....PLA-A42EA7

Outdoor Unit
Standard Model.....PUZ-A42NKA7

Seacoast Model.....PUZ-A42NKA7-BS

INDOOR UNIT FEATURES

- Space-efficient ductless installation
- Equipped with 3D i-see Sensor® for enhanced comfort and energy efficiency
- Airflow settings for high and low ceiling applications
- Individual vane settings for direct/indirect airflow control or variable airflow patterns
- Knockouts for outside-air intake and branch-duct run
- Filter indicator signal
- Easy-to-clean, washable filter (optional high-efficiency filter available - requires multi-function casement)
- Built-in condensate lift mechanism
- Ideal for retail shops, classrooms, office spaces, conference centers, building lobbies, and more
- Multiple control options available:
 - kumo cloud® smart device app for remote access
 - Third-party interface options
 - Wired or wireless controllers

OUTDOOR UNIT FEATURES

- Variable speed INVERTER-driven compressor
- Power receiver pre-charged with refrigerant volume for piping length up to 100 ft
- Low ambient cooling down to 0°F providing 100% capacity
- 24-hour continuous operation (cooling mode)
- High pressure protection
- Fast restart
- Superior energy and operational efficiency

SPECIFICATIONS: PLA-A42EA7 & PUZ-A42NKA7(-BS)

Cooling at 95°F ¹	Maximum Capacity	BTU/H	42,000
	Rated Capacity	BTU/H	42,000
	Minimum Capacity	BTU/H	16,000
	Maximum Power Input	W	3,590
	Rated Power Input	W	3,590
	Moisture Removal	Pints/h	7.9
	Sensible Heat Factor		0.79
Heating at 47°F ²	Maximum Capacity	BTU/H	48,000
	Rated Capacity	BTU/H	45,000
	Minimum Capacity	BTU/H	18,000
	Maximum Power Input	W	3,820
	Rated Power Input	W	3,290
	Power Factor [208V / 230V]	%	94.1 / 94.1
Heating at 17°F ³	Maximum Capacity	BTU/H	30,800
	Rated Capacity	BTU/H	28,000
	Maximum Power Input	W	3,110
	Rated Power Input	W	3,070
Heating at 5°F ⁴	Maximum Capacity	BTU/H	26,900
	Maximum Power Input	W	3,200
Efficiency	SEER		21.0
	EER ¹		11.6
	HSPF [IV]		9.3
	COP at 47°F ²		4.0
	COP at 17°F at Maximum Capacity ³		2.91
	COP at 5°F at Maximum Capacity ⁴		2.46
Electrical	ENERGY STAR® Certified		No
	Voltage, Phase, Frequency		208/230, 1, 60
	Guaranteed Voltage Range	V AC	198 - 253
	Voltage: Indoor - Outdoor, S1-S2	V AC	208/230
	Voltage: Indoor - Outdoor, S2-S3	V DC	24
	Short-circuit Current Rating [SCCR]	kA	5
	Recommended Fuse/Breaker Size (Outdoor)	A	30
	Recommended Wire Size [Indoor - Outdoor]	AWG	14
	Power Supply		Indoor unit is powered by the outdoor unit
	Indoor Unit	MCA	A
Fan Motor Full Load Amperage		A	0.95
Fan Motor Type			DC Motor
Airflow Rate at Cooling, Dry		CFM	740-920-1,060-1,200
Airflow Rate at Cooling, Wet		CFM	700-880-1,020-1,160
Airflow Rate at Heating, Dry		CFM	740-920-1,060-1,200
Sound Pressure Level [Cooling]		dB[A]	34-38-42-45
Sound Pressure Level [Heating]		dB[A]	34-38-42-45
Drain Pipe Size		In. [mm]	1-1/4 [32]
Condensate Lift Mechanism, Maximum Distance		In. [mm]	33-7/16 [849]
Coating on Heat Exchanger			—
External Finish Color			White Munsell 6.4Y 8.9/0.4
Unit Dimensions		W x D x H: In. [mm]	33-1/16 // 37-13/32 x 33-1/16 // 37-13/32 x 11-3/4 // 1-9/16 [840 // 950 x 840 // 950 x 298 // 40]
Package Dimensions		W x D x H: In. [mm]	35-9/16 // 39-6/16 x 34-5/16 // 38-3/16 x 16-9/16 // 4-12/16 [903 // 1,000 x 871 // 970 x 421 // 121]
Unit Weight		Lbs. [kg]	56 // 11 [25 // 5]
Package Weight	Lbs. [kg]	77 [35]	
Indoor Unit Operating Temperature Range	Cooling Intake Air Temp [Maximum / Minimum]*	°F	90 DB, 72 WB / 66 DB, 61 WB
	Heating Intake Air Temp [Maximum / Minimum]	°F	77 DB / 59 DB

NOTES:

AHRI Rated Conditions

(Rated data is determined at a fixed compressor speed)

¹Cooling (Indoor // Outdoor)

²Heating at 47°F (Indoor // Outdoor)

³Heating at 17°F (Indoor // Outdoor)

°F 80 DB, 67 WB // 95 DB, 75 WB

°F 70 DB, 60 WB // 47 DB, 43 WB

°F 70 DB, 60 WB // 17 DB, 15 WB

*Indoor/Outdoor Unit Operating Temperature Range (Cooling Air Temp [Maximum / Minimum]):

• Applications should be restricted to comfort cooling only; equipment cooling applications are not recommended for low ambient temperature conditions.

» Wind baffles required to operate below 23°F DB in cooling mode.

» Heat pump system with wind baffle: 0°F - 115°F.

» Refer to wind baffle documentation for further information.

**Outdoor Unit Operating Temperature Range (Cooling Thermal Lock-out / Re-start Temperatures; Heating Thermal Lock-out / Re-start Temperatures):

• System cuts out in heating mode to avoid thermistor error and automatically restarts at these temperatures.

SEACOAST PROTECTION (-BS MODELS)

• External Outer Panel: Phosphate coating + Acrylic-Enamel coating

• Fan Motor Support: Epoxy resin coating (at edge face)

• Separator Assembly Valve Bed: Epoxy resin coating (at edge face)

• Blue Fin treatment is an anti-corrosion treatment that is applied to the condenser coil to protect it against airborne contaminants.

SPECIFICATIONS: PLA-A42EA7 & PUZ-A42NKA7(-BS)

Outdoor Unit	MCA	A	25.0	
	MOCP	A	31	
	Fan Motor Full Load Amperage	A	0.5 + 0.5	
	Airflow Rate [Cooling / Heating]	CFM	3880 / 3880	
	Refrigerant Control		LEV	
	Defrost Method		Reverse Cycle	
	Coating on Heat Exchanger		Blue Fin Coating (BS Model only)	
	Sound Pressure Level, Cooling ¹	dB(A)	52	
	Sound Pressure Level, Heating ²	dB(A)	53	
	Compressor Type		INVERTER-driven twin rotary	
	Compressor Model		MNB33FBRC-L	
	Compressor Rated Load Amps	A	8	
	Compressor Locked Rotor Amps	A	13.0	
	Compressor Oil [Type // Charge]	oz.	FV50S // 45	
	External Finish Color		Ivory Munsell 3Y 7.8/1.1	
	Base Pan Heater		N/A	
	Unit Dimensions	W x D x H: In. [mm]	41-5/16 x 13 (+1-3/16) x 52-11/16 [1050 x 330 (+30) x 1338]	
	Package Dimensions	W x D x H: In. [mm]	42-15/16 x 17-11/16 x 56-4/16 [1091 x 450 x 1429]	
	Unit Weight	Lbs. [kg]	214 [97]	
	Package Weight	Lbs. [kg]	245 [111]	
	Outdoor Unit Operating Temperature Range	Cooling Air Temp [Maximum / Minimum]*	°F	115 DB / 0 DB
		Heating Air Temp [Maximum / Minimum]	°F	70 DB, 59 WB / -4 DB, -4 WB
		Heating Thermal Lock-out / Re-start Temperatures**	°F	-8 / -4
Refrigerant	Maximum Charge Quantity	Lbs, oz	10.0, 6.0	
	Initial Charge Quantity	Ft. [m]	0.0 [30.0]	
	Additional Refrigerant Charge Per Additional Piping Length	oz./Ft. [g/m]	0.7 [50]	
Piping	Gas Pipe Size O.D. [Flared]	In.[mm]	5/8 [15.88]	
	Liquid Pipe Size O.D. [Flared]	In.[mm]	3/8 [9.52]	
	Maximum Piping Length	Ft. [m]	165 [50]	
	Maximum Height Difference	Ft. [m]	100 [30]	
	Maximum Number of Bends		15	

NOTES:

AHRI Rated Conditions

(Rated data is determined at a fixed compressor speed)

¹Cooling (Indoor // Outdoor)

°F 80 DB, 67 WB // 95 DB, 75 WB

²Heating at 47°F (Indoor // Outdoor)

°F 70 DB, 60 WB // 47 DB, 43 WB

³Heating at 17°F (Indoor // Outdoor)

°F 70 DB, 60 WB // 17 DB, 15 WB

*Indoor/Outdoor Unit Operating Temperature Range (Cooling Air Temp [Maximum / Minimum]):

- Applications should be restricted to comfort cooling only; equipment cooling applications are not recommended for low ambient temperature conditions.
 - » Wind baffles required to operate below 23°F DB in cooling mode.
 - » Heat pump system with wind baffle: 0°F - 115°F.
 - » Refer to wind baffle documentation for further information.

**Outdoor Unit Operating Temperature Range (Cooling Thermal Lock-out / Re-start Temperatures; Heating Thermal Lock-out / Re-start Temperatures):

- System cuts out in heating mode to avoid thermistor error and automatically restarts at these temperatures.

SEACOAST PROTECTION (-BS MODELS)

- External Outer Panel: Phosphate coating + Acrylic-Enamel coating
- Fan Motor Support: Epoxy resin coating (at edge face)
- Separator Assembly Valve Bed: Epoxy resin coating (at edge face)
- Blue Fin treatment is an anti-corrosion treatment that is applied to the condenser coil to protect it against airborne contaminants.

INDOOR UNIT ACCESSORIES: PLA-A42EA7

Control Interface	3-Pin Connector	PAC-715AD
	BACnet® and Modbus® Interface	PAC-UKPRC001-CN-1
	CN24 Relay Kit	CN24RELAY-KIT-CM3
	IT Extender	PAC-WHS01IE-E
	kumo station® for kumo cloud®	PAC-WHS01HC-E
	Lockdown bracket for remote controller	RCMKP1CB
	Remote Operation Adapter†	PAC-SF40RM-E
	Thermostat Interface	PAC-US444CN-1
	Thermostat Interface	PAC-US445CN-1
	USNAP Adapter	PAC-WHS01UP-E
	Wireless Interface for kumo cloud®	PAC-USWHS002-WF-2
Remote Sensor	Flush Mount Remote Temperature Sensor	PAC-USSEN002-FM-1
	Flush Mount Temperature Sensor	PAC-USSEN001-FM-1
	Remote Temperature Sensor	PAC-SE41TS-E
	Wireless temperature and humidity sensor for kumo cloud®	PAC-USWHS003-TH-1
Wired Remote Controller	Airzone ZBS Wired Blueface Principal Controller White	AZZBSBLUEFACECB
	Airzone ZBS Wired Lite Controller White	AZZBSLITECB
	Airzone ZBS Wired Think Controller White	AZZBSTHINKCB
	Airzone ZBS Wireless Lite Controller White	AZZBSLITERB
	Airzone ZBS Wireless Think Controller White	AZZBSTHINKRB
	Deluxe Wired MA Remote Controller†	PAR-40MAAU
	Simple MA Remote Controller†	PAC-YT53CRAU-J
	Touch MA Controller†	PAR-CT01MAU-SB
Wireless Remote Controller	kumo touch™ RedLINK™ Wireless Controller	MHK2
	Wireless MA Receiver	PAR-FA32MA-W
	Wireless MA Remote Controller	PAR-FL32MA-E
	Wireless Remote Controller	PAR-SL101A-E
	Wireless Signal Receiver	PAR-SA9FA-E
	Wireless Signal Receiver Panel	PAR-SR4LU-E
Casement	Multi-function Casement	PAC-SJ41TM-E
Condensate	Blue Diamond (Advanced) Mini Condensate Pump w/ Reservoir & Sensor (208/230V) [recommended]	X87-721
	Blue Diamond (MegaBlue Advanced) Condensate Pump w/ Reservoir & Sensor	X87-835
	Blue Diamond Sensor Extension Cable — 15 Ft.	C13-103
	Refoco Condensate Pump (100-240 VAC) up to 120,000 BTU/H	COMBI
Disconnect Switch	(30A/600V/UL) [fits 2" X 4" utility box] - Black	TAZ-MS303
	(30A/600V/UL) [fits 2" X 4" utility box] - White	TAZ-MS303W
Filter	High Efficiency Filter Element**	PAC-SH59KF-E
i-see Sensor® Panel	Grille with 3D i-see Sensor® (required)	PLP-41EAEU
Lineset	10' x 3/8" x 10' x 5/8" Lineset (Twin-Tube Insulation)††	MPLS385812T-10
	100' x 3/8" x 100' x 5/8" Lineset (Twin-Tube Insulation)††	MPLS385812T-100
	15' x 3/8" x 15' x 5/8" Lineset (Twin-Tube Insulation)††	MPLS385812T-15
	30' x 3/8" x 30' x 5/8" Lineset (Twin-Tube Insulation)††	MPLS385812T-30
	50' x 3/8" x 50' x 5/8" Lineset (Twin-Tube Insulation)††	MPLS385812T-50
	65' x 3/8" x 65' x 5/8" Lineset (Twin-Tube Insulation)††	MPLS385812T-65
Shutter Plate	Shutter Plate	PAC-SJ37SP-E
Space Panel	Space Panel	PAC-SJ38AS-E

NOTES:

†PAC-SF40RM-E (Unable to use with wireless remote controller)

OUTDOOR UNIT ACCESSORIES: PUZ-A42NKA7(-BS)

Air Outlet Guide	Air Outlet Guide (1 Piece)	PAC-SG59SG-E
	Air Outlet Guide (1 Piece)	PAC-SH96SG-E (two pieces are required)
Control/Service Tool	Control/Service Tool	PAC-SK52ST
	M- & P-Series Maintenance Tool Cable Set	M21EC0397
	USB/UART Conversion Cable (Required for all laptop connection)	M21EC1397
Drain Socket	Drain Socket	PAC-SG61DS-E
M-NET Converter	M-NET Converter	PAC-SJ85MA-E
	M-NET Converter	PAC-SJ95MA-E
Mini-Split Wire	14 Gauge, 4 wire MiniSplit Cable—250 ft. roll	S144-250
	14 Gauge, 4 wire MiniSplit Cable—50 ft. roll	S144-50
	16 Gauge, 4 wire MiniSplit Cable—250 ft. roll	S164-250
	16 Gauge, 4 wire MiniSplit Cable—50 ft. roll	S164-50
Mounting Pad	Condensing Unit Mounting Pad: 24" x 42" x 3"	ULTRILITE2
Stand	18" Dual Fan Stand	QSMS1802M
	24" Dual Fan Stand	QSMS2402M
	Condenser Wall Bracket	QSWB2000M-1
	Condenser Wall Bracket - Stainless Steel Finish	QSWBSS
	Outdoor Unit Stand — 12" High	QSMS1202M
Wind Baffle	Front Wind Baffle	WB-PA3 (two pieces are required)
	Rear Wind Baffle	WB-RE6
	Side Advanced Wind Baffle	WB-SD6

INDOOR UNIT DIMENSIONS: PLA-A42EA7

Unit: inch (mm)

1. NOTE: CHOOSE THE GRILLE AMONG THE DESIGNATED GRILLES.
2. REINFORCE THE SUSPENSION BOLT FOR EARTHQUAKE-RESISTANCE AS NEEDED.
3. PROCEED AT THE LOCAL SITE.
4. FOR DRAIN PIPE, USE W-2410, H-1411, (2) PVC TUBE.
5. DRAIN IS MADE BY CONNECTION FROM THE CEILING.
6. ELECTRICAL BOX MAY BE REMOVED FOR THE SERVICE PURPOSE.
7. REQUIRE "E" OR MORE SPACE BETWEEN RANSOM AND CEILING FOR THE INSTALLATION.
8. WHEN INSTALLING THE BRANCH DUCTS, BE SURE TO INSULATE ADEQUATELY.
9. AS FOR NECESSARY INSTALLATION SERVICE SPACE, PLEASE REFER TO THE MULTIFUNCTIONAL CASEMENT REFER TO SPECIAL DRAWING.

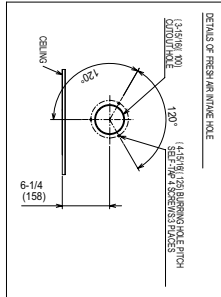
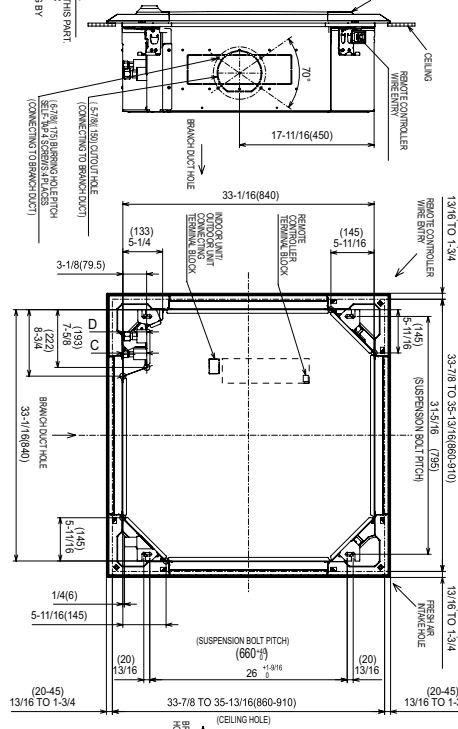
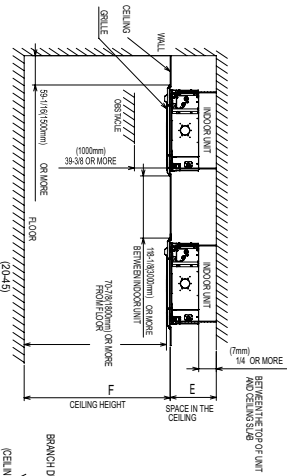
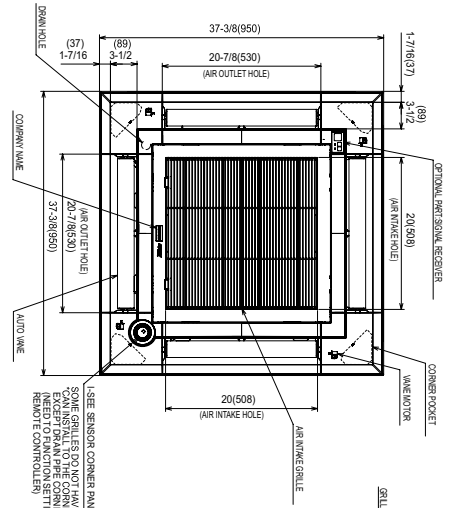

MODELS	①	②	A	B	C	D	E	F
REGULATED PREHEAT	4-1/2 (113)	10-3/8 (268)	3-7/8 (98.5)	3-7/8 (98.5)	10-1/2 (267)	10-1/2 (267)	10-1/2 (267)	10-1/2 (267)
UNREGULATED PREHEAT	5-1/8 (135)	11-1/8 (289)	3-7/8 (98.5)	3-7/8 (98.5)	11-1/8 (289)	11-1/8 (289)	11-1/8 (289)	11-1/8 (289)
REGULATED PREHEAT	4-1/2 (113)	10-3/8 (268)	3-7/8 (98.5)	3-7/8 (98.5)	10-1/2 (267)	10-1/2 (267)	10-1/2 (267)	10-1/2 (267)
UNREGULATED PREHEAT	5-1/8 (135)	11-1/8 (289)	3-7/8 (98.5)	3-7/8 (98.5)	11-1/8 (289)	11-1/8 (289)	11-1/8 (289)	11-1/8 (289)

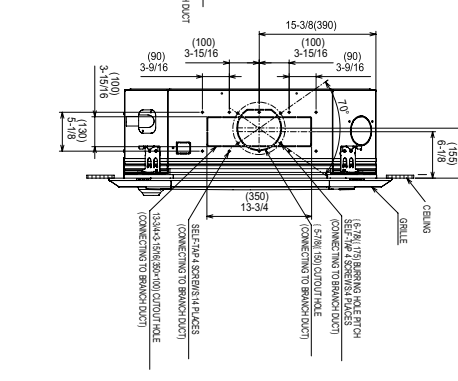
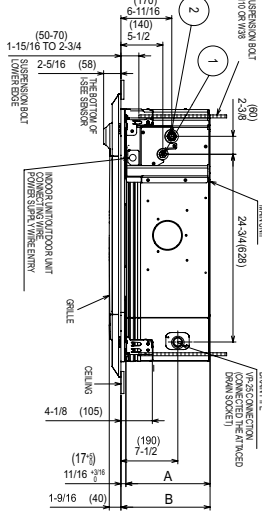
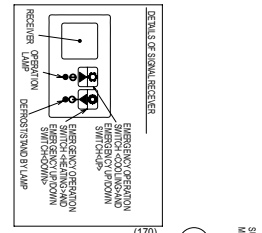

OUTDOOR UNIT DIMENSIONS: PUZ-A42NKA7(-BS)

Unit: mm<in>

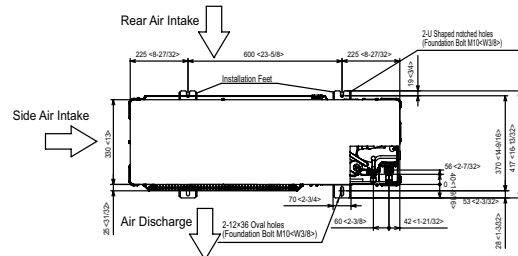
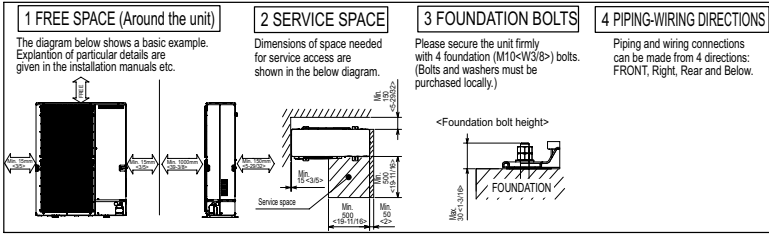

Example of Notes

- ① - Refrigerant GAS pipe connection (FLARE) ϕ 15.88(5/8F)
- ② - Refrigerant LIQUID pipe connection (FLARE) ϕ 9.52(3/8F)
- *1 ... Indication of STOP VALVE connection location.

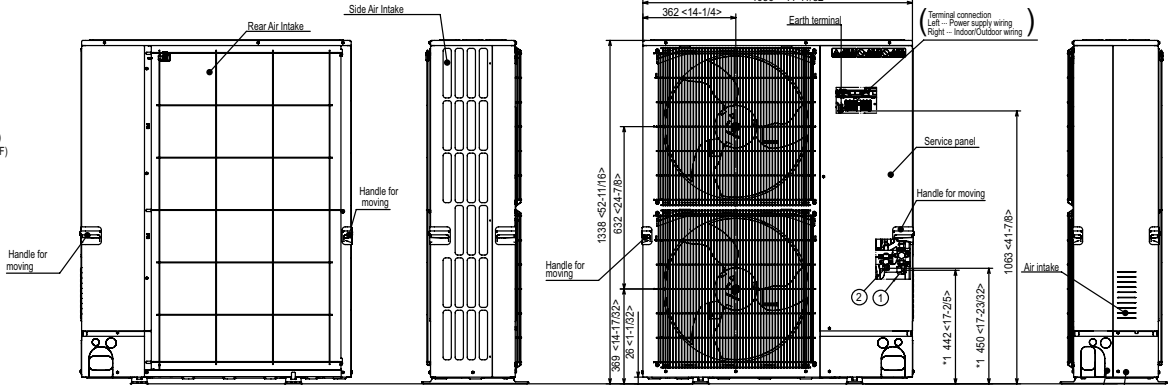

Piping Knockout Hole Details

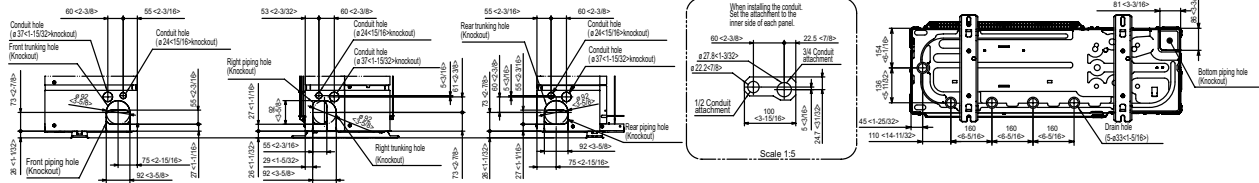

1340 Satellite Boulevard Suwanee, GA 30024
Toll Free: 800-433-4822 www.mehvac.com



FORM# PLA-A42EA7 & PUZ-A42NKA7(-BS) - 202209